



BFM Europe

BRITISH FIRE MANUFACTURERS

THE
COLLECTION
by Michael Miller

Kohlangaz

FLAVEL

CELSI
...the future of fire



PREMIUM GAS & ELECTRIC FIRES COLLECTION 2020

WELCOME

At BFM Europe we know how important it is to create a stylish and relaxing environment. We understand the blend of form and function, crafting high quality with superb energy efficiency.

A fire is never just a fire. It's a statement of innovation that brings a home to life. In this collection we proudly bring to you a range of beautiful Gas and Electric fires. A fire is never just a fire. It's a statement of innovation that brings a home to life. I hope you enjoy choosing your new fire.



Michael Jones



THE MM COLLECTION



FLAVEL



KOHLANGAZ



CELSI



OUR GUARANTEE TO YOU

Every gas fire carries a comprehensive guarantee providing you with reassurance and peace of mind for many years to come.

Our gas fire guarantees protect your fire against manufacturing and material defects, including parts and labour, subject to our 'Conditions of Guarantee'. Including annual service by a Gas Safe Registered engineer to ensure continued safe operation and optimum performance throughout the lifetime of the product.

Our Celsi electric fires carry a 2 year guarantee which applies to the electric fire engine.

Surrounds and fascias are subject to 12 months guarantee.



This logo signifies that the product is fully compliant with the Eco design directive Commission Regulation (EU) 2015/1188.

bsi. PRODUCT TESTING & CERTIFICATION

All our gas fires are independently tested, approved and verified by the British Standards Institution (BSI) to meet the latest standards for performance, safety and efficiency.

The BSI is an independent organisation. They are not owned by the government, industry or shareholders, which means that they can be totally objective with regards testing and certification. This gives their assessments more authority than those of an organization that has a vested interest in promoting its members.

They have some of the most experienced and knowledgeable staff in the world and are recognised internationally for their technical expertise, quality services and in-depth knowledge of gas and electrical product testing and certification.

The wide-ranging capability of their testing facilities and the broad expertise and knowledge of their testing and certification staff ensures our products are rigorously tested with the utmost integrity.



Carmelo HE, LPG Compatible* – Page 13



Gosford HE, LPG Compatible* – Page 18



Emberglow, LPG Compatible* – Page 32

THE COLLECTION

by Michael Miller

high efficiency gas fires

Conventional Flue

Surround Inset - Glass Fronted

Da Vinci MD 8

Wall Inset - Glass Fronted

Aleesia 9

Asencio 10

Celena* 11

Eden Elite* 12



Passion HE, LPG Compatible* – Page 14-15

Hearth Inset - Glass Fronted

Passion HE* & Accessories 14-15

Balanced Flue

Wall Inset - Glass Fronted

Celena Slimline BF 11

Eden Elite Slimline BF 12

Carmelo HE* 13

*LPG Compatible

Kohlangaz

high efficiency gas fires

Conventional Flue

Wall Inset - Glass Fronted

Ashbourne 16

Brandon 17

Hearth Inset - Glass Fronted

Gosford HE* 18

Hearth Inset - Open Fronted

Gosford Plus* 19

Gosford 20

Delamere Plus* 21

Marbury Plus 22

Balanced Flue

Hearth Inset - Glass Fronted

Durlston* 23

standard gas fires

Conventional Flue

Hearth Inset - Open Fronted

Marbury 24

Delamere 25

Thetford 26-27

Kohlangaz fire accessories 28-29

FLAVEL

high efficiency gas fires

Conventional Flue

Hearth Inset - Glass Fronted

Windsor Contemporary HE 30

Windsor Traditional HE 31

Hearth Outset - Glass Fronted

Emberglow* 32

Renoir 33

Hearth Outset - Open Fronted

Regent 34

Welcome 35

Strata 36

Misermatic 37

Renaissance 38

Firenza 39

Balanced Flue

Hearth Outset - Glass Fronted

Emberglow BF 32

standard gas fires

Conventional Flue

Hearth Inset - Open Fronted

Windsor Contemporary, Classic & Traditional 40

Hearth Outset - Open Fronted

Regent LFE 41



Electrifiame VR Orbital Illumia – Page 49



Ultifiame VR Designer – Page 70



PREMIUM ELECTRIC FIRES

Electrifiame VR

Glass Fronted

Outlet Suites

| | |
|--------------------------|-------|
| E-VR Volare 1100 Illumia | 42-43 |
| E-VR Media 1100 Illumia | 44 |
| E-VR Carino 1100 Illumia | 45 |
| E-VR Volare 750 Illumia | 46 |
| E-VR Media 750 Illumia | 47 |
| E-VR Carino 750 Illumia | 48 |
| E-VR Orbital Illumia | 49 |

Wall Outlet 3 sided

| | |
|-----------|----|
| E-VR 1400 | 50 |
| E-VR 1100 | 51 |
| E-VR 750 | 52 |

Wall Outlet

| | |
|---------------|----|
| E-VR Louvre | 53 |
| E-VR Basilica | 54 |

Wall Inset

| | |
|---------------|----|
| E-VR Commodus | 55 |
| E-VR Metz | 56 |
| E-VR Vichy | 57 |

Hearth Inset

| | |
|-------------------|----|
| E-VR Acero | 58 |
| E-VR Parrilla | 59 |
| E-VR Contemporary | 60 |

Electristove VR

Glass Fronted

Outlet Stoves

| | |
|----------------|----|
| E-VR Rochester | 61 |
| E-VR Arundel | 62 |
| E-VR Luxima | 63 |



Electrifiame VR Parrilla – Page 59

Ultifiame VR

Open Fronted

Outlet Suites

| | |
|----------------------|----|
| U-VR Tory Illumia | 64 |
| U-VR Rathlin Illumia | 65 |
| U-VR Gola | 66 |
| U-VR Aran | 67 |

Hearth Inset

| | |
|---------------|----|
| U-VR Camber | 68 |
| U-VR Frontier | 69 |
| U-VR Designer | 70 |

Flamonik

Glass Fronted

Wall Outlet

| | |
|---------|----|
| Rapture | 71 |
| Enchant | 72 |

Accent

Open Fronted

Hearth Inset

| | |
|--------------------|----|
| Accent Traditional | 73 |
| Accent Infusion | 74 |

Electristove XD

Glass Fronted

Outlet Stoves

| | |
|-------------------|----|
| E-XD Metal 1&2 | 75 |
| E-XD Glass 1&2 | 75 |
| Purastove Glass 2 | 77 |



Purastove Glass 2 – Page 77

| | |
|-----------------------------|-------|
| Fire Dimensions | 78-86 |
| Balanced Flue Installations | 87 |

GAS FIRES - BEFORE YOU BEGIN

TYPE OF CHIMNEY OR FLUE

The type of chimney or flue you have dictates the type of fire you can have. But if you're not sure, then take a look at your roof and compare it with the simple guide below. It's worth remembering that a full depth fire often requires a traditional chimney or rebate on the fire surround, whilst a slimline fire will fit virtually any chimney or flue.



Brick Chimney - Class 1 Flues

Apart from products designed for "no chimney" applications, all Flavel products will fit brick chimneys. They are easily recognisable by a chimney stack with accompanying terracotta pot or gas terminal.



Pre-Fabricated Flue - Class 2 Flues

Pre-fabricated flues are easily identifiable by a metal flue and terminal on the roof and a metal flue box behind the fire.



Pre-Cast Flue

Pre-cast flues can be identified by a ridge vent or metal flue tube and terminal on the roof. Constructed from concrete or clay blocks they form a rectangular section flue. All Flavel fires featuring this icon are only suitable for Pre-Cast flues conforming to BS EN 1858.

CAN'T SEE A CHIMNEY OR FLUE?

If you can't see a chimney or flue like the ones described on the left, then you will require a Balanced Flue.



Balanced Flue

Balanced Flue fires use a horizontal pipe to vent directly outside. An electricity supply is not required for Balanced Flue products.

CONTROLS



Manual Control

A simple and discreet control system located behind the fire's trim or fret on Inset fires and the bottom right side on outlets.



Electronic Flame Control

Discreet easy access buttons are used to ignite the fire and adjust heat and flame height.



Slide Control

Convenient control that eliminates the necessity of bending down.



Remote Control with Thermostat

The remote control handset can be used to light the fire as well as to adjust the flame height and heat output. In addition, the handset contains the extra benefit of a thermostatic control to regulate room temperature and a programmable timer that can be pre-programmed to ensure your room will be warm whenever you wish.



Top Control

A push down and twist ignition and control located on the top of outset fires means you don't have to bend down to light the fire.



Remote Control

The remote control handset is used to light the fire as well as adjust the flame height and heat output.



Electronic Top or Side Control System

Both ignition and heat are controlled by a single rotary motion to light the fire. These easy to use controls are now available on our best selling radiant outlets. Requires an AA battery.

GAS SUPPLY

Your gas supply will either be natural gas or LPG, depending on the area in which you live.



Natural Gas

If you have a gas meter then you will have natural gas.



LPG

LPG is the most popular alternative to natural gas.

FUEL BEDS



Coal



Pebble



Logs



Driftwood



Decorative Flame

FIRE BACK PANELS



Plain Black



Black Enamel



Brick Effect



Ribbed Cream



Ribbed Black



Cream Vermiculite

ELECTRIC FIRES - ADVANCED FEATURES



THERMOSTATIC HEATING

Pre-set your heat comfort level for automatic temperature control via the handset.



TIMER FUNCTION

Programmable 7-day heating timer function with hourly on/off control. ⌚ Upto 8 hrs sleep timer facility available on some models.



LED EFFICIENCY

From controllable flame picture and fuel bed brightness, to colour changing mood lighting, our onboard LED's ensure effective energy saving low power consumption.



ISOFLAME

Independent flame effect capable of displaying in isolation when no heat is required from the appliance.



FLAME FUSION

Captivating Indigo blue flame feature creates a colourful impression by fusing soft and natural yellow flames with an attractive flare of blue flame intensity.



COLOUR CYCLE

Fix your favourite or go dynamic as you cycle through an array of impressive colour changing fuel bed options.



MOOD LIGHTS

Designed to enhance your experience with an ambient stream of colour rich soft LED lighting. Select from a choice of colours to compliment both warm and cool home interiors, or simply to suit your mood.



ECODESIGN COMPLIANT

Integrated design features for optimal energy saving performance and assurance.



Surround Inset – Glass Fronted **high**efficiency



MM-44 Integrated Dual Flame Burner Technology

The Da Vinci mid-depth gas fire is sure to be the centre of attention in any home. The fire provides highly realistic log ceramics, paired with the latest MM-44 Dual Burner Technology, delivering log burning flame integration set against a beautiful deep black reflective enamel interior, creating a stunning contrast finish.

This fire is available as a conventional flue model, suitable for installation into any standard brick chimney or pre-fabricated flue, with a maximum heat output of 6.8kW. It features our multi-functional remote control system with thermostatic and timer functions. Non-reflective glass provides an exceptionally clear vision of this most natural and truly vibrant living flame gas fire.

**This gas fire is designed to be installed in a natural stone surround.
Ask your fireplace retailer about suitable surrounds.**

SPECIFICATION

| | | CONVENTIONAL FLUE |
|--------------------------|--------------|--------------------------------|
| | | Natural Gas |
| Useful energy efficiency | | 71.9% |
| Energy efficiency class | | E |
| Direct heat output | | 6.8kW |
| Control | | Multifunctional Remote Control |
| Model Number | Black Enamel | DDCLRBN3 |

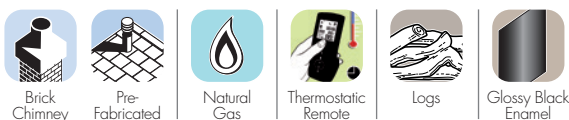

Wall Inset – Glass Fronted **high efficiency**



Black Enamel Interior



Panoramic Flame Burner Technology



Rustic Brick Interior



Cream Vermiculite Interior

This efficient landscape gas fire benefits from virtually invisible non-reflective glass, along with highly detailed ceramic logs.

Captivating flames flow throughout the fuel effect and enhance the interior lining creating reflection in the black enamel, or light and shadows in the cream vermiculite, or rustic brickwork.

It is operated by a multifunctional remote control system with thermostatic and timer functions allowing you to pre-set your desired room temperature and control when the fire turns on and off.

SPECIFICATION

| | | CONVENTIONAL FLUE | |
|--------------------------|-------------------|--------------------------------|--|
| | | Natural Gas | |
| Useful energy efficiency | | 74.8% | |
| Energy efficiency class | | E | |
| Direct heat output | | 4.2kW | |
| Control | | Multifunctional Remote Control | |
| Model Number | Black Enamel | DDALBERN | |
| | Cream Vermiculite | DDAIVTRN | |
| | Brick Effect | DDALBBRN | |



Brick Chimney



Pre-Fabricated



Natural Gas



Thermostatic Remote



Logs



Glossy Black Enamel



Brick Effect



Cream Vermiculite



Wall Inset – Glass Fronted **high**efficiency



Brick Effect Interior
Black Nickel & Chrome Fascia



Panoramic Flame Burner Technology



Black Enamel Interior
Black Nickel & Chrome Fascia

The Asencio gas fire has been designed to look beautiful and perform brilliantly. Accommodating tall flowing flames ascending from natural appearance logs, this fire provides a sensational fuel effect showcase for your living area. A thermostatic remote control system allows you to select the times you want the fire to automatically turn on or off with pre-set temperature functionality to select your desired heating comfort level.

Featuring non-reflective glass this highly efficient gas fire has a direct heat output of 4.0kW, and is available with a choice of interior liners in glossy black enamel, rustic brick effect, or cream vermiculite. Installation is suitable in to most standard chimneys.

SPECIFICATION

| | | CONVENTIONAL FLUE |
|--------------------------|-------------------|--|
| | | Natural Gas |
| Useful energy efficiency | | 77.1% |
| Energy efficiency class | | D |
| Direct heat output | | 4.0kW |
| Control | | Fully Automatic Remote with Thermostatic Control |
| Model Number | Black Enamel | DDCLBERN2 |
| | Rustic Brick | DDCLBSRN2 |
| | Cream Vermiculite | DDCLVTRN2 |



Black Enamel Interior
Chrome Fascia



Cream Vermiculite Interior
Black Fascia



Wall Inset – Glass Fronted **high efficiency**



Conventional Flue Black Enamel Interior
Black Nickel & Chrome Fascia



*Slimline balanced flue fuel effect



Slimline Balanced Flue
Black Enamel Interior
Chrome Fascia

The elegant and highly efficient Celena comes with non-reflective glass, a thermostatic remote-control system, and is available with 'chunky logs' - conventional flue, and slimline logs - balanced flue model. With upto 3.9kW this desirable gas fire provides beautiful tall dancing flames, whilst delivering real warmth at the heart of your home.

*Slimline balanced flue model requires a spacer when installing into a standard cavity wall.

SPECIFICATION

| | | CONVENTIONAL FLUE | | SLIMLINE BALANCED FLUE |
|--------------------------|-------------------|--|------------|------------------------|
| | | Natural Gas | LPG | Natural Gas |
| Useful energy efficiency | | 79.3% | 78.5% | 90.5% |
| Energy efficiency class | | D | D | B |
| Direct heat output | | 3.8kW | 3.9kW | 3.9kW |
| Control | | Fully Automatic Remote with Thermostatic Control | | |
| Model Number | Black Enamel | DPRLBERN2B | DPRLBERP2B | DCBLBERNB |
| | Rustic Brick | DPRLBBRN2B | DPRLBBRP2B | DCBLBBRNB |
| | Cream Vermiculite | DPRLTVRN2B | DPRLTVRP2B | DCBLTVRNB |

*80mm Spacer 1184-1001079A



Conventional Flue
Rustic Brick Effect Interior
Brass Fascia



Conventional Flue
Cream Vermiculite Interior
Black Fascia



Wall Inset – Glass Fronted

high efficiency



Conventional Flue Black Enamel Interior
Black Fascia



Slimline Balanced Flue
Black Enamel Interior
Brushed Satin Silver Fascia



Conventional Flue
Tiled Effect Cream Vermiculite Interior
Black Fascia

The Eden Elite is our slimmest wall Inset gas fire with up to 85.6% energy efficiency and an impressive 4.9kW heat output. It is operated by a thermostatic remote control system to perfectly control your comfort.

The conventional flue model is designed to be easily installed into almost any chimney without compromising on the stunning log fuel effect and flame aesthetics. It comes in a choice of cream vermiculite or glossy black enamel back panel.

There is also a slimline balanced flue model for homes without a chimney or flue which is only available with a glossy black enamel back panel.

The Eden Elite is a non-reflective glass fronted fire that can be fitted with or without a fascia. Fascia options are available in brushed satin silver or black semi satin finish.

SPECIFICATION

| | | CONVENTIONAL FLUE | | SLIMLINE BALANCED FLUE |
|--------------------------|-------------------|--|-----------|------------------------|
| | | Natural Gas | LPG | Natural Gas |
| Useful energy efficiency | | 78.6% | 69% | 85.6% |
| Energy efficiency class | | D | E | C |
| Direct heat output | | 4.9kW | 4.3kW | 3.7kW |
| Control | | Fully Automatic Remote with Thermostatic Control | | |
| Model Number | Black Enamel | DEELELRNB | DEELELRPB | DBELEBRNB |
| | Cream Vermiculite | DEELVRNB | - | - |



Brick Chimney



Pre-Fabricated



Balanced Flue



Natural Gas



LPG



Thermostatic Remote



Logs



Glossy Black Enamel



Cream Vermiculite

CONVENTIONAL FLUE



SLIMLINE BALANCED FLUE



Wall Inset – Glass Fronted **high efficiency**



With its large size and enchanting flame picture the Carmelo HE hole in the wall balanced flue gas fire is certainly a show-stopper and it provides exceptional performance too.

If you're looking for luxury combined with exceptional heat output then the Carmelo HE is the ideal gas fire for you. With a viewing area measuring 1145mm along with an enchanting flame picture reflecting in its glossy black enamel interior, this hole in the wall balanced flue gas fire has a heat output of 6.4kW and 75.4% Useful energy efficiency, providing exceptional performance too.

What's more this fire can be installed almost anywhere in the home since it uses a balanced flue system with a choice of horizontal flue, vertical flue or chimney conversion flue kits available to choose from. Both log and white stone fuel effects are supplied with every fire.

SPECIFICATION

| | BALANCED FLUE | |
|--------------------------|---|-----------|
| | Natural Gas | LPG |
| Useful energy efficiency | 75.4% | |
| Energy efficiency class | E | |
| Direct heat output | 6.4kW | 6.6kW |
| Flue | Horizontal and Vertical Kits and Chimney Conversion Kit available | |
| Control | Fully Automatic Remote with Thermostatic Control | |
| Model Number | DCML00RN2 | DCML00RP2 |



Balanced Flue



Natural Gas



LPG



Thermostatic Remote



Logs



Glossy Black Enamel



Hearth Inset – Glass Fronted **high efficiency**

Passion HE is a market leading gas fire with the authentic look and feel of a real log fire, combining efficiency and performance with unique style and aesthetics.

Designed with large frame wide-angle viewing, this fire displays a lively fuel effect with natural ascending tall flames that reflect in the deep glossy black enamel interior.

For optimum aesthetics this fire can be supplied with non-reflective glass that provides an astonishingly crystal-clear view of the fuel bed. For comfort and performance choose our fully automatic remote-control option.



Ultimo trim in Gold & Black
Bauhaus 151 fret in Gold

SPECIFICATION

| | | CONVENTIONAL FLUE | | |
|--------------------------|-------------------|-------------------|-----------|-----------|
| | | Natural Gas | | LPG |
| Control | | Manual | Remote | Remote |
| Useful energy efficiency | | 82.3% | 82.6% | 79.7% |
| Energy efficiency class | | D | C | D |
| Direct heat output | | 4.0kW | | 3.6kW |
| Model Number | Standard Glass | DLBLOOMNB | DLBLOORNB | - |
| | Non Reflect Glass | - | DLBLNRRNB | DLBLNRRPB |



Brick Chimney



Pre-Fabricated



Natural Gas



LPG



Thermostatic Remote



Logs



Glossy Black Enamel



TRIMS

STANDARD

Quality steel trims in a choice of four colours with a plated or painted finish.



Brass



Chrome



Satin Silver



Black

SIGNATURE

The Signature is a quality steel fabricated trim in a range of metallic and paint finishes.



Brass & Black



Chrome & Black



Satin Silver & Chrome



Black Nickel & Chrome



Black Nickel & Black

ULTIMO

The Ultimo is a cast iron trim with a black painted and optional colour plated finish.



Gold & Black



Chrome & Black



Black Nickel & Black

FRETS

BAUHAUS 18"



Gold



Chrome



Satin Silver



Black Nickel



Black

BAUHAUS 151



Gold



Silver



Black Nickel

FASCIAS

ULTIMO 007

For a contemporary style we offer the Ultimo 007 one-piece fascia in three metallic colours.



Gold & Black



Chrome & Black



Black Nickel & Black

PROVENCE

Provence fascia made from cast iron in a matt black finish.



Black

MM SIGNATURE

The MM Signature is a one-piece fabricated steel fascia available in five colour choices.



Brass & Black



Chrome & Black



Satin Silver & Chrome



Black Nickel & Chrome



Black Nickel & Black

EMBRACE

The Embrace is a one-piece cast iron fascia in a combination of black painted with optional colour plated finish.



Gold & Black



Chrome & Black



Black Nickel & Black

ARCADIA

The Arcadia is a one-piece cast iron fascia in a combination of black painted with optional colour plated finish.



Black & Gold



Black & Chrome

Wall Inset – Glass Fronted **high efficiency**



Black Nickel & Chrome Fascia



The Ashbourne is a statement of pure luxury. This designer inset gas fire will not only deeply satisfy your heating requirement, but also aesthetically impress you with the most realistic and beautifully natural log fuel bed appearance. Between the raised logs are tall reaching bright yellow flames that provide wonderful contrast when reflecting against the glossy black enamel interior.

SPECIFICATION

| | | CONVENTIONAL FLUE |
|--------------------------|------|-------------------|
| | | Natural Gas |
| Useful energy efficiency | | 85.1% |
| Energy efficiency class | | C |
| Direct heat output | | 4.1kW |
| Control | | Remote |
| Model Number | Logs | HPHLCNRN |



Brick Chimney



Pre-Fabricated



Natural Gas



Thermostatic Remote



Logs



Glossy Black Enamel



Wall Inset – Glass Fronted **high efficiency**





Black Nickel & Chrome Fascia



Designed with petite proportions the Brandon inset gas fire is perfect for modern living areas where space can be at a premium. Beautiful dancing flames flow around highly realistic logs and form an attractive fuel bed with stunning contrast set against a glossy black enamel interior. The Brandon has been designed to make an impression. It will complement your home and providing long lasting efficient heat.

SPECIFICATION

| | | CONVENTIONAL FLUE |
|--------------------------|------|-------------------|
| | | Natural Gas |
| Useful energy efficiency | | 81.4% |
| Energy efficiency class | | D |
| Direct heat output | | 3.2kW |
| Control | | Remote |
| Model Number | Logs | HHCLNRRN |

- 
Brick Chimney
- 
Pre-Fabricated
- 
Natural Gas
- 
Thermostatic Remote
- 
Logs
- 
Glossy Black Enamel



Hearth Inset – Glass Fronted **high efficiency**



Embrace Fascia in Chrome & Black



Signature Trim in Black Nickel & Black
and Aviva Fret in Black Nickel

If you're looking for a gas fire with efficiency in mind this has to be the product for you. The Gosford HE glass fronted fire features our most realistic full depth coal effect fuel bed and boasts an incredible energy efficiency of 86.3%. With a massive 4.0kW output the Gosford HE keeps your heat high and your fuel costs low. You can choose your preferred fascias, trims and frets combination to suit your décor, see page 28-29 for more details.

SPECIFICATION

| | | CONVENTIONAL FLUE | | | |
|--------------------------|------|-------------------|----------|-----------|----------|
| | | Natural Gas | | LPG | |
| Useful energy efficiency | | 86% | | 86.3% | |
| Energy efficiency class | | C | | C | |
| Direct heat output | | 3.9kW | | 4.0kW | |
| Control | | Manual | Slide | Remote | Slide |
| Model Number | Coal | HHEC00MN | HHEC00SN | HHEC00RN2 | HHEC00SP |

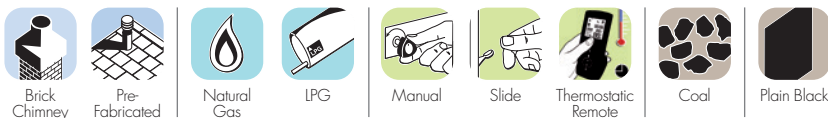

Hearth Inset – Open Fronted **high**efficiency



Signature Trim in Chrome & Black
and Aviva Fret in Chrome



Signature Fascia in Black Nickel & Black

The Gosford Plus is our first full depth open-fronted high efficiency gas fire. You can now achieve the look of a real open coal fire at an incredible 66.7% energy efficiency. Suitable for installation into standard chimneys or pre-fabricated flues the Gosford Plus comes in a choice of manual or slide control and can be styled to suit your home with our wide range of fascias, trims and frets (see pages 28-29).

SPECIFICATION

| | | CONVENTIONAL FLUE | | |
|--------------------------|------|-------------------|-----------|----------|
| | | Natural Gas | | LPG |
| Useful energy efficiency | | 66.7% | | 66.2% |
| Energy efficiency class | | F | | F |
| Direct heat output | | 4.1kW | | 4.2kW |
| Control | | Manual | Slide | Slide |
| Model Number | Coal | HOPC00MN2 | HOPC00SN2 | HOPC00SP |



Brick Chimney



Pre-Fabricated



Natural Gas



LPG



Manual



Slide



Coal



Plain Black



Hearth Inset – Open Fronted **high**efficiency



Arcadia Fascia in Black & Gold







Signature Trim in Black Nickel & Chrome
with Blenheim Fret in Antique Chrome

The Gosford features one of the most realistic coal effects on the market and offers an amazing 3.7kW of heat. This open fronted fire is able to deliver a higher output through the use of a heat exchanger which draws in the cool room air and converts it to warm convected air. Manual or slide control models are available and you can create your own style with a choice of any Kohlangaz fascias, trims or frets (see pages 28-29).

SPECIFICATION

| | | CONVENTIONAL FLUE | |
|--------------------------|------|-------------------|-----------|
| | | Natural Gas | |
| Useful energy efficiency | | 60% | |
| Energy efficiency class | | F | |
| Direct heat output | | 3.7kW | |
| Control | | Manual | Slide |
| Model Number | Coal | HICC00MN2 | HICC00SN2 |

- 
Brick Chimney
- 
Pre-Fabricated
- 
Natural Gas
- 
Manual
- 
Slide
- 
Coal
- 
Plain Black



Hearth Inset – Open Fronted **high efficiency**



Pebble fuel effect with Dalliance Fascia in Chrome



Coal fuel effect with Standard Trim and Blenheim Fret in Brass

The Delamere Plus boasts an amazing 68.3% energy efficiency and can be installed in to almost any chimney or flue, including pre-cast when fitted with a 3" rebated fire surround. This open-fronted gas fire features a highly realistic coal fuel effect and is available as a manual or slide controlled fire. A pebble fuel effect is available as an optional extra. You can create your own style with a choice of any Kohlangaz fascia, trim or fret (see pages 28-29).

SPECIFICATION

| | | CONVENTIONAL FLUE | | |
|--------------------------|-------------|-------------------|-----------|----------|
| | | Natural Gas | | LPG |
| Useful energy efficiency | | 68.3% | | 67% |
| Energy efficiency class | | F | | F |
| Direct heat output | | 4.2kW | | 4.2kW |
| Control | | Manual | Slide | Slide |
| Model Number | Coal/Pebble | HKPC00MN2 | HKPC00SN2 | HKPC00SP |



Hearth Inset – Open Fronted **high efficiency**



Pebble fuel effect with Signature Fascia in Black Nickel & Black



Coal fuel effect with Standard Trim and Grace Fret in Chrome

The Marbury Plus is one of the most efficient open-fronted slimline gas fires available today and with a heat output of up to 4.0kW it is also one of the warmest products suitable for a pre-cast flue. The Marbury Plus is available in a choice of manual or slide control. This extremely versatile fire can be styled with a wide range of Kohlangaz fascias, trims or frets and with an optional pebble fuel bed it is easy to create a look to suit your existing décor. See pages 28-29 for more information about Kohlangaz accessories.

SPECIFICATION

| | | CONVENTIONAL FLUE | |
|--------------------------|-------------|-------------------|----------|
| | | Natural Gas | |
| Control | | Manual | Slide |
| Useful energy efficiency | | 66.8% | |
| Energy efficiency class | | F | |
| Direct heat output | | 4.0kW | 3.8kW |
| Model Number | Coal/Pebble | HSPC00MN2 | HSPC00SN |

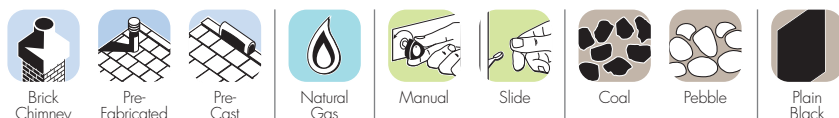

Hearth Inset – Glass Fronted **high efficiency**



Log fuel effect with Standard Trim and Chrome Grace Fret



Coal fuel effect with Standard Trim and Brass Daisy Fret

The Durlston Balanced Flue is the perfect solution for those who like the look of a full depth fire but don't have a standard chimney or flue in their home. At 93.5% energy efficiency this glass fronted fire is the most efficient product in our range and offers an impressive 3.9kW heat output. It comes in a choice of manual or Easy Flame Control and can be teamed with a range of Kohlangaz fascia, trim and fret options. This fire can be installed easily into most standard cavity walls when fitted with a 3" rebated fire surround.

SPECIFICATION

| | | BALANCED FLUE | | |
|--------------------------|------|---------------|------------|-----------|
| | | Natural Gas | | LPG |
| Useful energy efficiency | | 93.5% | | 93.5% |
| Energy efficiency class | | B | | B |
| Direct heat output | | 3.9kW | | 4.0kW |
| Control | | Manual | Easy Flame | Manual |
| Model Number | Coal | HBFC00MN2 | HBFC00EN3 | HBFC00MP2 |
| | Logs | HBFL00MN | - | - |



Hearth Inset – Open Fronted **standardfires**



Coal fuel effect with Signature Trim and Daisy Fret in Satin & Chrome



Pebble fuel effect with Contemporary Fascia in Satin Silver

The slimline Marbury gas fire features an attractive coal fuel bed and dancing flame effect. It is suitable for installation in to almost any home since it will fit a standard brick chimney, pre-fabricated flue or pre-cast (BS EN 1858). This fire can be purchased as a manual control fire or as a convenient slide control. A pebble fuel effect is available as an optional extra. See pages 28-29 for fascia, trim and fret combinations.

SPECIFICATION

| | | CONVENTIONAL FLUE | |
|--------------------------|-------------|-------------------|----------|
| | | Natural Gas | |
| Control | | Manual | Slide |
| Useful energy efficiency | | 53.1% | |
| Energy efficiency class | | F | |
| Direct heat output | | 3.1kW | |
| Model Number | Coal/Pebble | HNVC00MN | HNVC00SN |

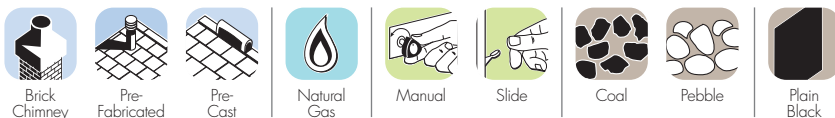

Hearth Inset – Open Fronted **standardfires**



Coal fuel effect with Ultimo Trim and Daisy Fret in Antique Brass



Pebble fuel effect with Ultimo Trim in Chrome & Black and Grace Fret in Satin Silver & Chrome

The Delamere features an outstanding coal or optional pebble fuel effect and a beautiful flame picture. This open fronted fire provides a maximum heat output of 2.7kW and can be installed into most chimneys or flues, including pre-cast (BS EN 1858) when fitted with a 3" rebated fire surround. Customise the Delamere with our extensive range of fascias, trims and frets (see pages 28-29).

SPECIFICATION

| | | CONVENTIONAL FLUE | |
|--------------------|-------------|-------------------|-----------|
| | | Natural Gas | |
| Control | | Manual | Slide |
| Direct heat output | | 2.7kW | |
| Model Number | Coal/Pebble | HRDC00MN2 | HRDC00SN2 |

This product is not suitable for primary heating purposes.

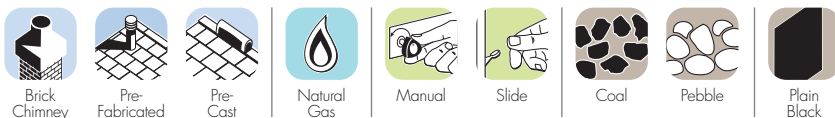



The Thetford features one of the deepest looking fuel beds on a slimline gas fire. Designed for easy installation in to any chimney or flue, including pre-cast (BS EN 1858), this stylish fire is both versatile and affordable. This model comes with a choice of Standard trim which can be teamed with any Kohlangaz fret, or upgrade to one of our Contemporary fascias (see pages 28-29). A pebble fuel effect is available as an optional extra.



Coal fuel effect with Signature Trim and Blenheim Fret in Antique Brass



Pebble fuel effect with Standard Trim and Grace Fret in Chrome

SPECIFICATION

| | | CONVENTIONAL FLUE |
|--------------------|-------------|-------------------|
| | | Natural Gas |
| Control | | Manual |
| Direct heat output | | 2.7kW |
| Model Number | Coal/Pebble | HSRC00MN |

This product is not suitable for primary heating purposes.



Fascias

Contemporary fascias

The Contemporary is a one-piece fabricated steel fascia. Not available with slide control or Easy Flame Control system. Unsuitable for Gosford Plus or Durlston Balanced Flue models.



Chrome



Satin Silver



Brass

Dalliance fascias

The Dalliance is a one-piece fabricated steel fascia. Available in a choice of metallic or Black Painted finish. Suitable for all models and control types.



Chrome



Satin Silver



Black Painted

Signature fascias

The Signature is a one-piece fabricated steel fascia. Suitable for all models and control types. Unsuitable for Durlston BF model.



Chrome & Black



Satin Silver & Chrome



Brass & Black



Black Nickel & Chrome



Black Nickel & Black

Embrace fascias

Arcadia fascias

The Embrace and Arcadia are a one-piece cast iron fascias in a combination of Black Painted and optional colour plated finish. Suitable for all Kohlangaz models apart from those with an Easy Flame Control system.



Gold & Black



Chrome & Black



Black Nickel & Black



Black & Gold



Black & Chrome

Trims

The Standard and Signature are quality steel fabricated trims in a range of metallic and paint finishes. Signature trim – the Brass & Black finish is unsuitable for Durlston BF model.

Standard trims



Brass

Black

Satin Silver

Chrome

Signature trims

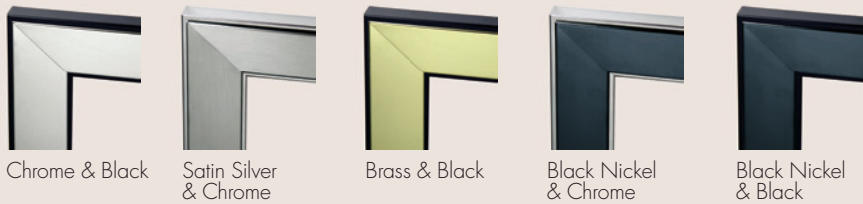

Chrome & Black

Satin Silver & Chrome

Brass & Black

Black Nickel & Chrome

Black Nickel & Black

The Designer are extruded anodised aluminium trims with a dual finish of metallic and paint.

Designer trims



Brass

Black & Brass

Brass & Black

Chrome

Black & Chrome

Chrome & Black

The Ultimo is a superior cast iron trim, black painted with a choice of metallic colour plating. Suitable for all Kohlangaz hearth inset fires apart from those with an Easy Flame Control system.

Ultimo trims



Gold & Black



Chrome & Black

Frets

The Blenheim and Daisy are traditionally styled frets made with Solid Brass or Cast Iron.

Blenheim frets



Brass

Antique Brass

Black Painted

Antique Chrome

Chrome

Daisy frets



Antique Brass

Black Nickel

Satin Silver & Chrome

The Grace and Aviva are Contemporary styled frets made with Solid Brass or Cast Iron.

Grace frets



Brass

Chrome

Satin Silver & Chrome

Aviva frets



Chrome

Black Nickel

Hearth Inset – Glass Fronted **high**efficiency



Chrome with Pebble fuel effect



Brass with Coal fuel effect

Stunning styling makes the Windsor Contemporary glass fronted high efficiency gas fire the centrepiece of your room. This slimline model will fit almost any chimney or flue, including pre-cast (BS EN 1858), and comes with a chrome or brass fascia.

SPECIFICATION

| | | CONVENTIONAL FLUE | |
|--------------------------|--------|-------------------|----------|
| | | Natural Gas | |
| Useful energy efficiency | | 81.3% | |
| Energy efficiency class | | D | |
| Direct heat output | | 2.9kW | |
| Control | | Manual | |
| | | Coal | Pebble |
| Model Number | Chrome | FSHCU0MN | - |
| | Brass | FSHCU1MN | - |
| | Chrome | - | FSHPU0MN |



Brick Chimney



Pre-Fabricated



Pre-Cast



Natural Gas



Manual



Coal



Pebble



Plain Black



WINDSOR TRADITIONAL HE



Hearth Inset – Glass Fronted **high**efficiency



Brass



Chrome

The Windsor Traditional HE glass fronted gas fire offers exceptional heat output of 2.9kW with an energy efficiency of 81.3% and is available in manual or slide control.

SPECIFICATION

| | | CONVENTIONAL FLUE | |
|--------------------------|--------|-------------------|-----------|
| | | Natural Gas | |
| Useful energy efficiency | | 81.3% | |
| Energy efficiency class | | D | |
| Direct heat output | | 2.9kW | |
| Control | | Manual | Slide |
| Model Number | Brass | FSHC11MN | FSHC11SN2 |
| | Chrome | FSHC3JMN | FSHC3JSN2 |



Brick Chimney



Pre-Fabricated



Pre-Cast



Natural Gas



Manual



Slide



Coal



Plain Black

Hearth Outset – Glass Fronted **high efficiency**



Balanced Flue

The Emberglow high efficiency outset gas fire features an elegant design with high quality cast iron canopy and fire front. With front and side windows the mesmerising dancing flames can be seen from all angles and it is operated by an easy to use electronic side control system.

The main image represents the natural gas model. The flame picture may differ on LPG model.

SPECIFICATION

| | CONVENTIONAL FLUE | | BALANCED FLUE | |
|--------------------------|---|-----------|---------------|----------|
| | Natural Gas | LPG | Natural Gas | |
| Useful energy efficiency | 78.7% | 81.6% | 82.2% | 86.9% |
| Energy efficiency class | E | D | D | C |
| Direct heat output | 4.2kW | 4.4kW | 4.2kW | 4.3kW |
| Flue | Brick Chimney, Pre-fabricated Flue, Pre-Cast Flue | | Horizontal | |
| Control | ES | Remote | ES | Manual |
| Model Number | FEMCO0EN | FEMCOORN2 | FEMCO0EP | FEBCO0MN |



Brick Chimney



Pre-Fabricated



Pre-Cast



Balanced Flue



Natural Gas



LPG



Manual



Electronic Side



Thermostatic Remote



Coal



Plain Black

* Only on Balanced Flue model.

Hearth Outset – Glass Fronted **high efficiency**



Bronze

The Renoir outset living flame effect gas fire features a beautiful flickering flame effect and is operated by an electronic side control system to make it much easier to ignite the fire. This classically designed fire has an impressive heat output of up to 4.4kW and energy efficiency of up to 81.6%.

SPECIFICATION

| | | CONVENTIONAL FLUE | |
|--------------------------|--------|-------------------|----------|
| | | Natural Gas | |
| Useful energy efficiency | | 78.7% | 81.6% |
| Energy efficiency class | | E | D |
| Direct heat output | | 4.2kW | 4.4kW |
| Control | | ES | Remote |
| Model Number | Black | FRECNOEN | FRECORN2 |
| | Bronze | FRECROEN | FRECORN2 |

- Brick Chimney
- Pre-Fabricated
- Pre-Cast
- Natural Gas
- Electronic Side
- Thermostatic Remote
- Coal
- Plain Black

Hearth Outset – Open Fronted **high efficiency**



Bronze

One of the most popular radiant fires in the UK, the Regent features a slim design and has an energy efficiency of 74%. The Regent is available in a choice of black or bronze finishes and is operated by electronic side control.

SPECIFICATION

| | | CONVENTIONAL FLUE |
|--------------------------|--------|-------------------|
| | | Natural Gas |
| Useful energy efficiency | | 74% |
| Energy efficiency class | | E |
| Direct heat output | | 4.5kW |
| Control | | ES |
| Model Number | Black | FRGCNOEN |
| | Bronze | FRGCPOEN |



Brick Chimney



Pre-Fabricated



Pre-Cast



Natural Gas



Electronic Side

Hearth Outset – Open Fronted **high efficiency**



Bronze



Black

The Welcome's beautiful electrically illuminated coal effect brings life to the room even when the heat is off, providing a charming focal point to any room. It also has a 74% energy efficiency, resulting in lower running costs.

SPECIFICATION

| | | CONVENTIONAL FLUE |
|--------------------------|--------|-------------------|
| | | Natural Gas |
| Useful energy efficiency | | 74% |
| Energy efficiency class | | E |
| Direct heat output | | 4.5kW |
| Control | | ES |
| Model Number | Black | FWERNOEN |
| | Bronze | FWERFOEN |



Brick Chimney



Pre-Fabricated



Pre-Cast



Natural Gas



Electronic Side



STRATA



Hearth Outset – Open Fronted **high efficiency**



Brown

The Strata offers an incredible energy efficiency of 82% and 5.2kW heat output. It has a stylish contemporary look with soft, curved lines and is available in a choice of three colour options. Can be wall mounted.



Black



Cream

SPECIFICATION

| | | CONVENTIONAL FLUE |
|--------------------------|-------|-------------------|
| | | Natural Gas |
| Useful energy efficiency | | 82% |
| Energy efficiency class | | D |
| Direct heat output | | 5.2kW |
| Control | | ET |
| Model Number | Black | FORSBLEN |
| | Brown | FORSBOEN |
| | Cream | FORSOEN |



Brick Chimney



Pre-Fabricated



Pre-Cast



Natural Gas



Electronic Top



MISERMATIC



Hearth Outset – Open Fronted **high efficiency**



Light Oak



Teak



Medium Oak



Mahogany



Black

Incredible 82% energy efficiency and adaptability; the Misermatic has them both. Available in a range of wood finishes, this fire can be wall or hearth mounted with an easily accessible top mounted control. Can be wall mounted.

SPECIFICATION

| | | CONVENTIONAL FLUE |
|--------------------------|------------|-------------------|
| | | Natural Gas |
| Useful energy efficiency | | 82% |
| Energy efficiency class | | D |
| Direct heat output | | 5.2KW |
| Control | | ET |
| Model Number | Mahogany | FORMMOEN |
| | Teak | FORMTOEN |
| | Light Oak | FORMLOEN |
| | Medium Oak | FORMNOEN |
| | Black | FORMBOEN |



Brick Chimney



Pre-Fabricated



Pre-Cast



Natural Gas



Electronic Top

Hearth Outset – Open Fronted **high efficiency**



Silver



Black

The Renaissance provides a natural talking point the moment you enter the room. Its stylish retro design is matched by its forward thinking simplicity of installation, impressive 5.2kW heat output and astounding 82% energy efficiency. Can be wall mounted.

SPECIFICATION

| | | CONVENTIONAL FLUE |
|--------------------------|--------|-------------------|
| | | Natural Gas |
| Useful energy efficiency | | 82% |
| Energy efficiency class | | D |
| Direct heat output | | 5.2kW |
| Control | | ET |
| Model Number | Silver | FORRSOEN |
| | Black | FORRBOEN |



Brick Chimney



Pre-Fabricated



Pre-Cast



Natural Gas



Electronic Top



FIRENZA



Hearth Outset – Open Fronted **high efficiency**



Bronze



Black

The compact and economical Firenza can be wall or hearth mounted and has an energy efficiency of 80.1%. The control handle is located on the top panel for ease of use.

SPECIFICATION

| | | CONVENTIONAL FLUE |
|--------------------------|--------|-------------------|
| | | Natural Gas |
| Useful energy efficiency | | 80.1% |
| Energy efficiency class | | D |
| Direct heat output | | 3.8kW |
| Control | | ET |
| Model Number | Black | FFIRZ1MN |
| | Bronze | FFIRROMN |



Brick Chimney



Pre-Fabricated



Pre-Cast



Natural Gas



Electronic Top

Hearth Inset – Open Fronted **standardfires**



Traditional with Brass Trim and Fret and Coal fuel effect



Contemporary with Chrome Fascia and Pebble fuel effect



Contemporary with Satin Silver Fascia and Driftwood fuel effect

The versatile styling of the Windsor gas fires ensures that there is a style to suit any room. This slimline gas fire will fit almost any chimney or flue, including pre-cast (BS EN 1858).

SPECIFICATION

| | | Contemporary | | | Classic | Traditional |
|--------------------|--------------|-------------------|----------|-----------|----------|-------------|
| | | Coal | Pebble | Driftwood | Coal | Coal |
| | | CONVENTIONAL FLUE | | | | |
| | | Natural Gas | | | | |
| Direct heat output | | 2.7kW | | | | |
| Control | | Manual | | | | |
| Model Number | Chrome | FSRCU0MN | FSRPU0MN | – | FSRC3WMN | FSRC3JMN |
| | Satin Silver | FSRC80MN | FSRP80MN | FSRDU0MN | – | – |
| | Brass | FSRCU1MN | – | – | FSRC1SMN | FSRC1PMN |



Classic with Chrome Trim and Fret and Coal fuel effect



Traditional with Chrome Trim and Fret and Coal fuel effect





REGENT LFE



Hearth Outset – Open Fronted **standardfires**



Black



Bronze

One of the most popular radiant fires in the UK, the Regent LFE is slim for a neat fit into an existing fireplace and is highly efficient. It provides radiant and convected heat and is an elegant interpretation of the Regency period.

SPECIFICATION

| | | CONVENTIONAL FLUE | |
|--------------------------|--------|-------------------|-----------|
| | | Natural Gas | |
| Useful energy efficiency | | 59.3% | |
| Energy efficiency class | | F | |
| Direct heat output | | 3.3kW | |
| Control | | ES | Remote |
| Model | Black | FRLCNOEN | FRLCNORN2 |
| Number | Bronze | FRLCPOEN | FRLCPORN2 |



Brick Chimney



Pre-Fabricated



Pre-Cast



Natural Gas



Electronic Side



Manual



Coal



Plain Black

ELECTRIFLAME VOLARE 1100

E-VR Outset Glass Fronted – Illumia Suite



THERMO-
STATIC



7 DAY
TIMER



ENERGY
SAVING



ISO
FLAME



FLAME
FUSION





Features

- Flame Projection Technology
- 3 sided glass fire
- Integrated lighting
- Customisable fuel effect
- Silver birch logs
- Crystal ash embers
- Single or dual colour flame
- LED brightness control
- Thermostatic remote & manual control operation
- Includes wall fixing bracket

SPECIFICATION

| | |
|----------------------|---------------------------------------|
| Suite Dimensions: mm | H-721 x W-1595 x D-406 |
| Heat Output | 1.0kW - 2.0kW |
| Suite Finish Painted | <input type="checkbox"/> Smooth White |

Optional Extras



Woodland logs fuel effect

E-VR Outset Glass Fronted – Illumia Suite



Features

- Flame Projection Technology
- 3 sided glass fire
- Integrated lighting
- Media storage
- Customisable fuel effect
- Silver birch logs
- Crystal ash embers
- Single or dual colour flame
- LED brightness control
- Thermostatic remote & manual control operation

Optional Extras



Woodland logs fuel effect

SPECIFICATION

| | |
|----------------------|---------------------------------------|
| Suite Dimensions: mm | H-1126 x W-1595 x D-408 |
| Heat Output | 1.0kW - 2.0kW |
| Suite Finish Painted | <input type="checkbox"/> Smooth White |



**THERMO-
STATIC**



**7 DAY
TIMER**



**ENERGY
SAVING**



**ISO
FLAME**



**FLAME
FUSION**



E-VR Outset Glass Fronted – Illumia Suite



Features

- Flame Projection Technology
- 3 sided glass fire
- Integrated lighting
- Customisable fuel effect
- Silver birch logs
- Crystal ash embers
- Single or dual colour flame
- LED brightness control
- Thermostatic remote & manual control operation

Optional Extras



Woodland logs fuel effect

SPECIFICATION

| | |
|----------------------|---------------------------------------|
| Suite Dimensions: mm | H-840 x W-1467 x D-370 |
| Heat Output | 1.0kW - 2.0kW |
| Suite Finish Painted | <input type="checkbox"/> Smooth White |



THERMO-
STATIC



7 DAY
TIMER



ENERGY
SAVING



ISO
FLAME



FLAME
FUSION



E-VR Outset Glass Fronted – Illumia Suite



Features

- Flame Projection Technology
- 3 sided glass fire
- Integrated lighting
- Customisable fuel effect
- Silver birch logs
- Crystal ash embers
- Single or dual colour flame
- LED brightness control
- Thermostatic remote & manual control operation

Optional Extras



Woodland logs fuel effect

SPECIFICATION

| | |
|-------------------------|---------------------------------------|
| Suite Dimensions: mm | H-721 x W-1400 x D-406 |
| Heat Output | 1.0kW - 2.0kW |
| Suite Finish Painted | <input type="checkbox"/> Smooth White |



THERMO-
STATIC



7 DAY
TIMER



ENERGY
SAVING



ISO
FLAME



FLAME
FUSION



E-VR Outset Glass Fronted – Illumia Suite



Features

- Flame Projection Technology
- 3 sided glass fire
- Integrated lighting
- Media storage
- Customisable fuel effect
- Silver birch logs
- Crystal ash embers
- Single or dual colour flame
- LED brightness control
- Thermostatic remote & manual control operation

Optional Extras



Woodland logs fuel effect

SPECIFICATION

| | |
|----------------------|---------------------------------------|
| Suite Dimensions: mm | H-1126 x W-1400 x D-408 |
| Heat Output | 1.0kW - 2.0kW |
| Suite Finish Painted | <input type="checkbox"/> Smooth White |



THERMO-
STATIC



7 DAY
TIMER



ENERGY
SAVING



ISO
FLAME



FLAME
FUSION



E-VR Outset Glass Fronted – Illumia Suite



Features

- Flame Projection Technology
- 3 sided glass fire
- Integrated lighting
- Customisable fuel effect
- Silver birch logs
- Crystal ash embers
- Single or dual colour flame
- LED brightness control
- Thermostatic remote & manual control operation

Optional Extras



Woodland logs fuel effect

SPECIFICATION

| | |
|-------------------------|---------------------------------------|
| Suite Dimensions: mm | H-840 x W-1118 x D-370 |
| Heat Output | 1.0kW - 2.0kW |
| Suite Finish Painted | <input type="checkbox"/> Smooth White |



THERMO-
STATIC



7 DAY
TIMER



ENERGY
SAVING



ISO
FLAME



FLAME
FUSION



E-VR Outset Glass Fronted – Illumia Suite



Features

- Flame Projection Technology
- Glass fronted fire
- Integrated lighting
- Customisable fuel effect
- Woodland logs
- Crystal ash embers
- Single or dual colour flame
- LED brightness control
- Thermostatic remote & manual control operation

SPECIFICATION

| | |
|----------------------|---------------------------------------|
| Suite Dimensions: mm | H-850 x W-1466 x D-360 |
| Heat Output | 0.8kW – 1.6kW |
| Suite Finish Painted | <input type="checkbox"/> Smooth White |



**THERMO-
STATIC**



**7 DAY
TIMER**



**ENERGY
SAVING**



**ISO
FLAME**



**FLAME
FUSION**



E-VR Wall Outset – Glass Fronted



Features

- Flame Projection Technology
- 3 sided glass fire
- Customisable fuel effect
- Woodland logs
- Crystal ash embers
- Single or dual colour flame
- LED brightness control
- Thermostatic remote & manual control operation
- Side blanking installation options

Optional Extras



Silver birch logs fuel effect

SPECIFICATION

| | |
|----------------------|------------------------|
| Suite Dimensions: mm | H-375 x W-1430 x D-275 |
| Heat Output | 1.0kW - 2.0kW |



THERMO-
STATIC



7 DAY
TIMER



ENERGY
SAVING



ISO
FLAME



FLAME
FUSION



E-VR Wall Outset – Glass Fronted



Features

- Flame Projection Technology
- 3 sided glass fire
- Customisable fuel effect
- Silver birch logs
- Crystal ash embers
- Single or dual colour flame
- LED brightness control
- Thermostatic remote & manual control operation
- Side blanking installation options

Optional Extras



Woodland logs fuel effect

SPECIFICATION

| | |
|----------------------|------------------------|
| Suite Dimensions: mm | H-374 x W-1430 x D-275 |
| Heat Output | 1.0kW - 2.0kW |



E-VR Wall Outset – Glass Fronted



Features

- Flame Projection Technology
- 3 sided glass fire
- Customisable fuel effect
- Silver birch logs
- Crystal ash embers
- Single or dual colour flame
- LED brightness control
- Thermostatic remote & manual control operation
- Side blanking installation options

Optional Extras



Woodland logs fuel effect

SPECIFICATION

| | |
|----------------------|-----------------------|
| Suite Dimensions: mm | H-374 x W-780 x D-275 |
| Heat Output | 0.8kW - 1.6kW |



THERMO-
STATIC



7 DAY
TIMER



ENERGY
SAVING



ISO
FLAME



FLAME
FUSION



E-VR Wall Outset – Glass Fronted



Features

- Flame Projection Technology
- Glass fronted fire
- Customisable fuel effect
- Woodland logs
- Crystal ash embers
- Single or dual colour flame
- LED brightness control
- Thermostatic remote & manual control operation
- Includes wall fixing bracket

SPECIFICATION

| | |
|--|--|
| Suite Dimensions: mm | H-519 x W-1102 x D-201 |
| Heat Output | 0.8kW - 1.6kW |
| Steel Fabricated & Glass Fascia Dual Finish Brushed Metallic |  Satin Silver & Black Glass |



**THERMO-
STATIC**



**7 DAY
TIMER**



**ENERGY
SAVING**



**ISO
FLAME**



**FLAME
FUSION**



E-VR Wall Outset – Glass Fronted



Satin Champagne

Features

- Flame Projection Technology
- Glass fronted fire
- Customisable fuel effect
- Woodland logs
- Crystal ash embers
- Single or dual colour flame
- LED brightness control
- Thermostatic remote & manual control operation
- Includes wall fixing bracket
- Wall inset option



Satin Silver

SPECIFICATION

| | |
|---|---|
| Suite Dimensions: mm | H-570 x W-1400 x D-90 |
| Heat Output | 0.8kW - 1.6kW |
| Steel Fabricated Fascia Brushed Metallic | <div style="display: flex; align-items: center;"> <div style="width: 20px; height: 20px; background-color: #ccc; margin-right: 5px;"></div> Satin Silver </div> <div style="display: flex; align-items: center; margin-top: 5px;"> <div style="width: 20px; height: 20px; background-color: #ddd; margin-right: 5px;"></div> Satin Champagne </div> |



E-VR Wall Inset – Glass Fronted



Features

- Flame Projection Technology
- Glass fronted fire
- Customisable fuel effect
- Woodland logs
- Crystal ash embers
- Single or dual colour flame
- LED brightness control
- Thermostatic remote & manual control operation

SPECIFICATION

| | |
|----------------------|-----------------------|
| Suite Dimensions: mm | H-330 x W-981 x D-169 |
| Heat Output | 0.8kW - 1.6kW |



THERMO-
STATIC



7 DAY
TIMER



ENERGY
SAVING



ISO
FLAME



FLAME
FUSION



E-VR Wall Inset – Glass Fronted



Features

- Flame Projection Technology
- Glass fronted fire
- Customisable fuel effect
- Woodland logs
- Crystal ash embers
- Single or dual colour flame
- LED brightness control
- Thermostatic remote & manual control operation



Satin Champagne

SPECIFICATION

| | |
|---|--|
| Suite Dimensions: mm | H-570 x W-1400 x D-24 |
| Heat Output | 0.8kW - 1.6kW |
| Steel Fabricated Fascia Brushed Metallic | <div style="display: flex; align-items: center;"> <div style="width: 20px; height: 20px; background-color: #ccc; margin-right: 5px;"></div> Satin Silver </div> <div style="display: flex; align-items: center; margin-top: 5px;"> <div style="width: 20px; height: 20px; background-color: #d9ead3; margin-right: 5px;"></div> Satin Champagne </div> |



E-VR Wall Inset – Glass Fronted



Satin Champagne

Features

- Flame Projection Technology
- Glass fronted fire
- Customisable fuel effect
- Woodland logs
- Crystal ash embers
- Single or dual colour flame
- LED brightness control
- Thermostatic remote & manual control operation



Satin Silver

SPECIFICATION

| | |
|---|---|
| Suite Dimensions: mm | H-523 x W-1653 x D-87 |
| Heat Output | 0.8kW - 1.6kW |
| Steel Fabricated Fascia Brushed Metallic | <input type="checkbox"/> Satin Silver <input type="checkbox"/> Satin Champagne |



**THERMO-
STATIC**



**7 DAY
TIMER**



**ENERGY
SAVING**



**ISO
FLAME**



**FLAME
FUSION**



E-VR Hearth Inset – Glass Fronted



Chrome & Black Nickel





Chrome & Satin Silver

Features

- **Aspirational 26 inch fascia**
- Flame Projection Technology
- Extra wide glass fronted fire
- Customisable fuel effect
- Woodland logs
- Crystal ash embers
- Single or dual colour flame
- LED brightness control
- Thermostatic remote & manual control operation

SPECIFICATION

| | |
|---|--|
| Suite Dimensions: mm | H-655 x W-657 x D-67 |
| Heat Output | 0.8kW - 1.6kW |
| Finishes Steel Fabricated Fascia Dual Finished Twin Metallic |  Chrome & Satin Silver  Chrome & Black Nickel |



THERMO-
STATIC



7 DAY
TIMER



ENERGY
SAVING



ISO
FLAME



FLAME
FUSION



E-VR Hearth Inset – Glass Fronted



Satin Champagne



Satin Silver

Features

- Flame Projection Technology
- Extra wide glass fronted fire
- Customisable fuel effect
- Woodland logs
- Crystal ash embers
- Single or dual colour flame
- LED brightness control
- Thermostatic remote & manual control operation

SPECIFICATION

| | |
|---|--|
| Suite Dimensions: mm | H-602 x W-544 x D-90 |
| Heat Output | 0.75kW - 1.5kW |
| Steel Fabricated Fascia Brushed Metallic | <div style="display: flex; align-items: center; gap: 10px;"> <div style="width: 15px; height: 15px; background-color: #ccc; border: 1px solid #000; margin-right: 5px;"></div> Satin Silver </div> <div style="display: flex; align-items: center; gap: 10px;"> <div style="width: 15px; height: 15px; background-color: #888; border: 1px solid #000; margin-right: 5px;"></div> Satin Champagne </div> |



THERMO-
STATIC



7 DAY
TIMER



ENERGY
SAVING



ISO
FLAME



FLAME
FUSION



E-VR Hearth Inset – Glass Fronted



Features

- Flame Projection Technology
- Extra wide glass fronted fire
- Customisable fuel effect
- Woodland logs
- Crystal ash embers
- Single or dual colour flame
- LED brightness control
- Thermostatic remote & manual control operation

SPECIFICATION

| | |
|---|---|
| Suite Dimensions: mm | H-602 x W-544 x D-90 |
| Heat Output | 0.75kW - 1.5kW |
| Steel Fabricated Fascia Brushed Metallic | <div style="display: flex; align-items: center;"> <div style="width: 20px; height: 20px; background-color: #ccc; margin-right: 5px;"></div> Satin Silver </div> <div style="display: flex; align-items: center; margin-top: 5px;"> <div style="width: 20px; height: 20px; background-color: #888; margin-right: 5px;"></div> Satin Champagne </div> |



E-VR Outset Stove – Glass Fronted



Woodland logs fuel effect

Features

- Flame Projection Technology
- Tough steel body
- Curved door design
- Customisable fuel effect
- Silver birch logs
- Crystal ash embers
- Single or dual colour flame
- LED brightness control
- Thermostatic remote & manual control operation

SPECIFICATION

| | |
|--------------------------|---|
| Suite Dimensions: mm | H-606 x W-532 x D-372 |
| Heat Output | 1.0kW - 2.0kW |
| Steel Fabricated Painted |  Black |



**THERMO-
STATIC**



**7 DAY
TIMER**



**ENERGY
SAVING**



**ISO
FLAME**



**FLAME
FUSION**



E-VR Outset Stove – Glass Fronted



Optional Extras



Woodland logs fuel effect

Features

- Flame Projection Technology
- Tough steel body
- Customisable fuel effect
- Silver birch logs
- Crystal ash embers
- Single or dual colour flame
- LED brightness control
- Thermostatic remote & manual control operation

SPECIFICATION

| | |
|--------------------------|---|
| Suite Dimensions: mm | H-582 x W-430 x D-389 |
| Heat Output | 0.75kW - 1.5kW |
| Steel Fabricated Painted |  Black |



THERMO-
STATIC



7 DAY
TIMER



ENERGY
SAVING



ISO
FLAME



FLAME
FUSION



E-VR Outset Stove – Glass Fronted



Optional Extras



Woodland logs fuel effect

Features

- Flame Projection Technology
- Tough steel body
- Customisable fuel effect
- Silver birch logs
- Crystal ash embers
- Single or dual colour flame
- LED brightness control
- Thermostatic remote & manual control operation

SPECIFICATION

| | |
|--------------------------|---|
| Suite Dimensions: mm | H-595 x W-471 x D-359 |
| Heat Output | 0.75kW - 1.5kW |
| Steel Fabricated Painted |  Black |



THERMO-
STATIC



7 DAY
TIMER



ENERGY
SAVING



ISO
FLAME



FLAME
FUSION



U-VR Outset Open Fronted – Illumia Suite



Features

- Open fire experience
- Integrated lighting
- Customisable fuel effect
- Woodland logs
- Crystal ash embers
- Single or dual colour flame
- LED brightness control
- Thermostatic remote & manual control operation



Woodland logs fuel effect

SPECIFICATION

| | |
|----------------------|---------------------------------------|
| Suite Dimensions: mm | H-1070 x W-1370 x D-340 |
| Heat Output | 0.8kW - 1.6kW |
| Painted | <input type="checkbox"/> Smooth White |



THERMO-
STATIC



7 DAY
TIMER



ENERGY
SAVING



ISO
FLAME



FLAME
FUSION



U-VR Outset Open Fronted – Illumia Suite



Features

- Open fire experience
- Integrated lighting
- Customisable fuel effect
- Woodland logs
- Crystal ash embers
- Single or dual colour flame
- LED brightness control
- Thermostatic remote & manual control operation



Woodland logs fuel effect

SPECIFICATION

| | |
|----------------------|---------------------------------------|
| Suite Dimensions: mm | H-1090 x W-1340 x D-380 |
| Heat Output | 0.8kW - 1.6kW |
| Painted | <input type="checkbox"/> Smooth White |



THERMO-
STATIC



7 DAY
TIMER



ENERGY
SAVING



ISO
FLAME



FLAME
FUSION



U-VR Outset Open Fronted – Illumia Suite



Features

- Open fire experience
- Integrated lighting
- Customisable fuel effect
- Woodland logs
- Crystal ash embers
- Single or dual colour flame
- LED brightness control
- Thermostatic remote & manual control operation



Woodland logs fuel effect

SPECIFICATION

| | |
|----------------------|---------------------------------------|
| Suite Dimensions: mm | H-990 x W-1465 x D-340 |
| Heat Output | 0.8kW - 1.6kW |
| Painted | <input type="checkbox"/> Smooth White |



THERMO-
STATIC



7 DAY
TIMER



ENERGY
SAVING



ISO
FLAME



FLAME
FUSION



U-VR Outset Open Fronted – Illumia Suite



Features

- Open fire experience
- Integrated lighting
- Customisable fuel effect
- Woodland logs
- Crystal ash embers
- Single or dual colour flame
- LED brightness control
- Thermostatic remote & manual control operation



Woodland logs fuel effect

SPECIFICATION

| | |
|----------------------|---------------------------------------|
| Suite Dimensions: mm | H-990 x W-1465 x D-380 |
| Heat Output | 0.8kW - 1.6kW |
| Painted | <input type="checkbox"/> Smooth White |



**THERMO-
STATIC**



**7 DAY
TIMER**



**ENERGY
SAVING**



**ISO
FLAME**



**FLAME
FUSION**



U-VR Hearth Inset – Open Fronted



Satin Silver



Woodland logs fuel effect



Satin Champagne



Black Textured

Features

- Open fire experience
- Customisable fuel effect
- Woodland logs
- Crystal ash embers
- Single or dual colour flame
- LED brightness control
- Thermostatic remote & manual control operation

SPECIFICATION

| | |
|---|--|
| Suite Dimensions: mm | H-619 x W-537 x D-135 |
| Heat Output | 0.75kW - 1.5kW |
| Anodised Aluminium Fascia Brushed Metallic or Black Textured Paint | <div style="display: flex; flex-direction: column; align-items: flex-start;"> <div style="display: flex; align-items: center; margin-bottom: 5px;"> <div style="width: 15px; height: 15px; background-color: #ccc; border: 1px solid #000; margin-right: 5px;"></div> Satin Silver </div> <div style="display: flex; align-items: center; margin-bottom: 5px;"> <div style="width: 15px; height: 15px; background-color: #ccc; border: 1px solid #000; margin-right: 5px;"></div> Satin Champagne </div> <div style="display: flex; align-items: center;"> <div style="width: 15px; height: 15px; background-color: #000; border: 1px solid #000; margin-right: 5px;"></div> Black Textured </div> </div> |

75mm spacer frame for flat wall installation.



THERMO-
STATIC



7 DAY
TIMER



ENERGY
SAVING



ISO
FLAME



FLAME
FUSION



U-VR Hearth Inset – Open Fronted



Woodland logs fuel effect

Features

- Open fire experience
- Customisable fuel effect
- Woodland logs
- Crystal ash embers
- Single or dual colour flame
- LED brightness control
- Thermostatic remote & manual control operation

SPECIFICATION

| | |
|--|--|
| Suite Dimensions: mm | H-617 x W-541 x D-131 |
| Heat Output | 0.75kW - 1.5kW |
| Steel Fabricated Fascia Dual Finish Paint & Metallic |  Black Textured & Chrome |

75mm spacer frame for flat wall installation.



**THERMO-
STATIC**



**7 DAY
TIMER**



**ENERGY
SAVING**



**ISO
FLAME**



**FLAME
FUSION**



U-VR Hearth Inset – Open Fronted



Woodland logs fuel effect





Chrome & Black

Features

- Open fire experience
- Customisable fuel effect
- Woodland logs
- Crystal ash embers
- Single or dual colour flame
- LED brightness control
- Thermostatic remote & manual control operation

SPECIFICATION

| | |
|--|---|
| Suite Dimensions: mm | H-599 x W-498 x D-129 |
| Heat Output | 0.75kW - 1.5kW |
| Finishes Steel Fabricated Fascia Dual Metallic |  Black Nickel & Chrome  Chrome & Black |

75mm spacer frame for flat wall installation.



Wall Outset – Glass Fronted



Features

- Flat glass fascia
- Distinctive flame effect
- Raised log fuel bed
- Thermostatic remote & manual control operation
- Includes wall fixing bracket

SPECIFICATION

| | |
|----------------------|---|
| Suite Dimensions: mm | H-440 x W-686 x D-110 |
| Heat Output | 0.75kW - 1.5kW |
| Finish |  Black Glass |



Magenta



Blue



Amber



Wall Outset – Glass Fronted



Features

- Curved glass fascia
- Enchanting smoky flame effect
- Raised log fuel bed
- Thermostatic remote & manual control operation
- Includes wall fixing bracket

SPECIFICATION

| | |
|----------------------|---|
| Suite Dimensions: mm | H-441 x W-916 x D-126 |
| Heat Output | 0.75kW - 1.5kW |
| Finish |  Black Glass |



Magenta



Blue



Amber



Hearth Inset – Open Fronted



Brass





Chrome

Features

- Lively Ribbon Flame Effect
- Coal effect fuel bed
- 3 LED flame brightness settings
- Thermostatic remote & manual control operation

SPECIFICATION

| | |
|--|---|
| Suite Dimensions: mm | H-595 x W-490 x D-35 |
| Heat Output | 1.0kW - 2.0kW |
| Steel Fabricated Metallic Plated Trim |  Brass  Chrome |



THERMO-
STATIC



8HR SLEEP
TIMER



ENERGY
SAVING



ISO
FLAME



Hearth Inset – Open Fronted



Chrome & Satin Silver



Brass & Black



Black & Chrome

Features

- Lively Ribbon Flame Effect
- Coal effect fuel bed
- 3 LED flame brightness settings
- Thermostatic remote & manual control operation

SPECIFICATION

| | |
|--|--|
| Suite Dimensions: mm | H-595 x W-498x D-83 |
| Heat Output | 1.0kW - 2.0kW |
| Steel Fabricated Fascia Dual Metallic & Painted | Brass & Black Black & Chrome Chrome & Satin Silver |



E-XD Outset Stove – Glass Fronted



Metal 1



Metal 2

Features

- Tough steel body
- High definition effect
- Extra deep 3D coals
- Relaxing smoky flames
- LED brightness control
- Thermostatic remote & manual control operation

SPECIFICATION

| | | |
|-----------------------|---|--|
| Dimensions: mm | Metal 1 Metal 2 | H-579 x W-430 x D-332 H-587 x W-524 x D-295 |
| Heat Output | 1.0kW - 2.0kW | |
| Steel Fabricated Body |  Black | |



THERMO-
STATIC



7 DAY
TIMER



ENERGY
SAVING



ISO
FLAME

METAL 1 



METAL 2 



E-XD Outset Stove – Glass Fronted



Glass 2



Glass 1

Features

- Tough steel body
- High definition effect
- Extra deep 3D coals
- Relaxing smoky flames
- LED brightness control
- Thermostatic remote & manual control operation

SPECIFICATION

| | | |
|-------------------------------------|--|--|
| Dimensions: mm | Glass 1 Glass 2 | H-583 x W-430 x D-334 H-591 x W-524 x D-295 |
| Heat Output | 1.0kW - 2.0kW | |
| Steel Fabricated Body Glass Door |  Black Glass & Chrome | |

Advanced Features Glass 1 only



E-XD Outset Stove – Glass Fronted



Features

- Ultra high technology experience
- Convincing real flame effects
- Exceptional functionality
- Thermostatic remote & manual control operation
- Contemporary glass door and stove top

SPECIFICATION

| | |
|---|-----------------------|
| Dimensions: mm | H-591 x W-524 x D-295 |
| Heat Output | 1.0kW - 2.0kW |
| Painted Steel Fabricated Glass Door & Stove Top | Black Glass & Chrome |



Surround Inset - Glass Fronted - 8

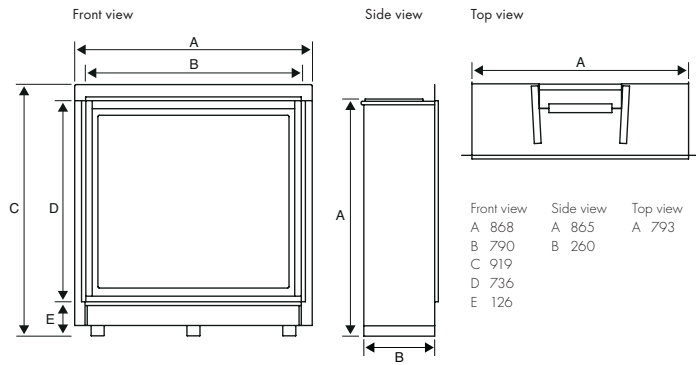

DA VINCI MD

Wall Inset - Glass Fronted - 9-13

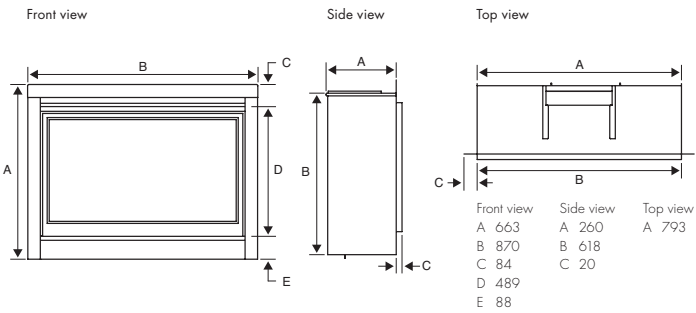

ALEESIA

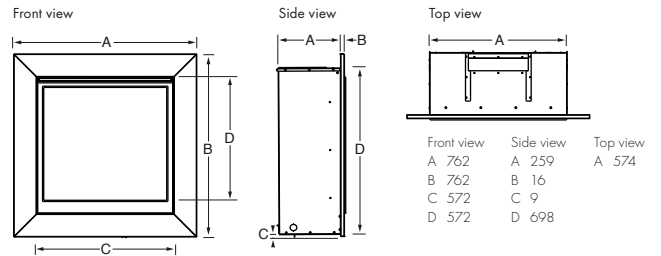

ASENCIO

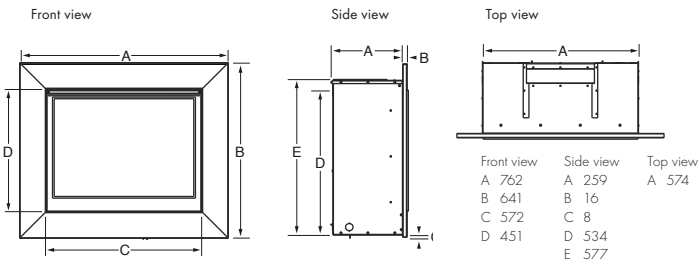

CELENA

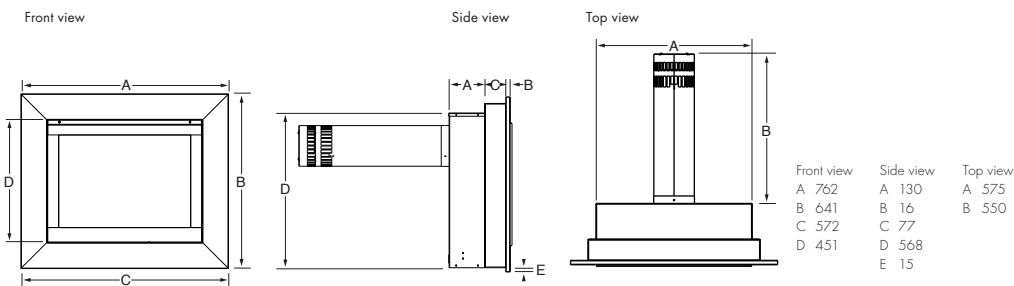

CELENA SLIMLINE BALANCED FLUE

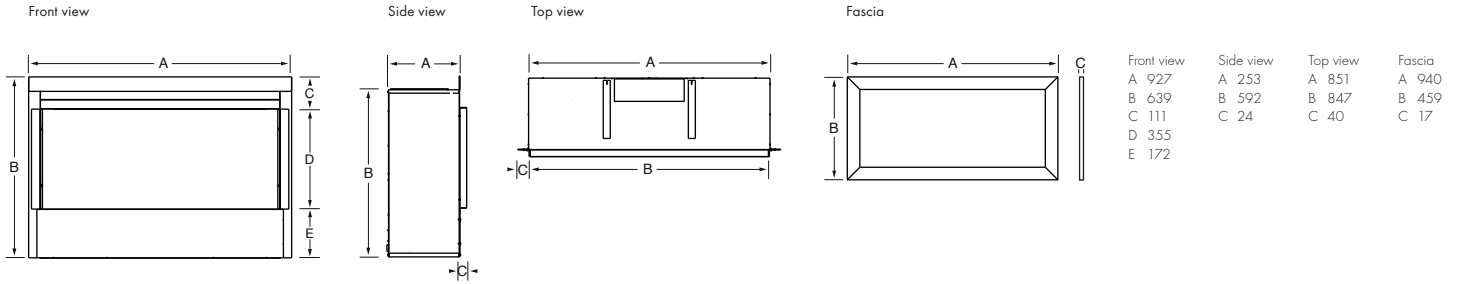

EDEN ELITE

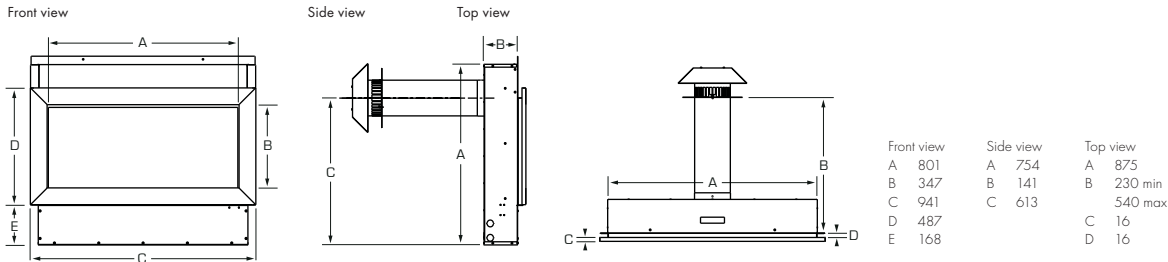

EDEN ELITE SLIMLINE BALANCED FLUE

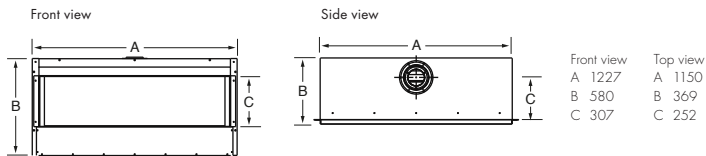

CARMELO

Hearth Inset - Glass Fronted - 14

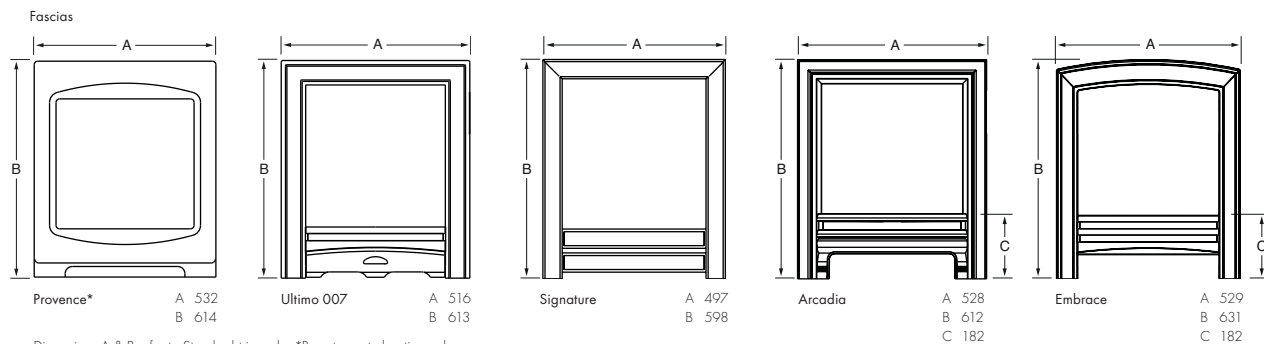
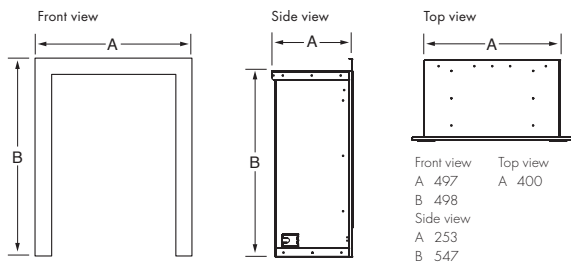

Dimensions A & B refer to Standard trim only. *Remote control option only

PASSION HE

Wall Inset - Glass Fronted – 16-17

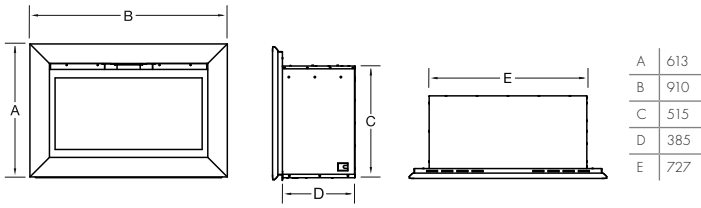

ASHBOURNE

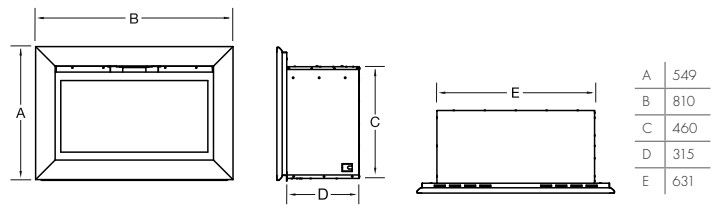

BRANDON

Hearth Inset - Glass Fronted – 18

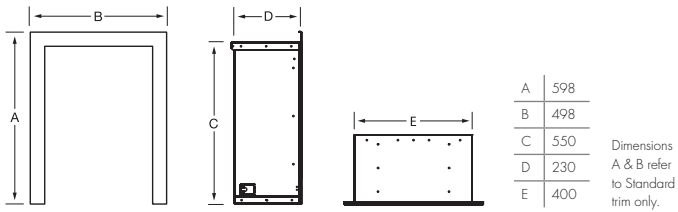

GOSFORD HE

Hearth Inset - Open Fronted – 19-22

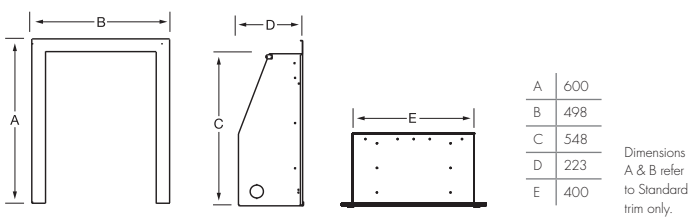

GOSFORD PLUS

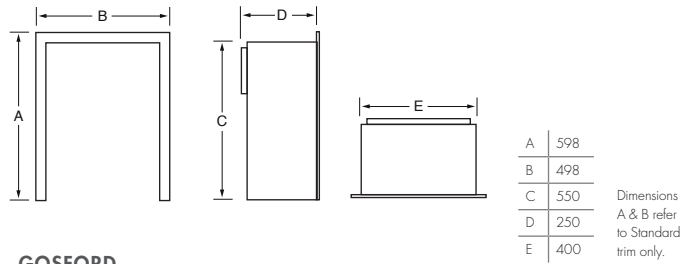

GOSFORD

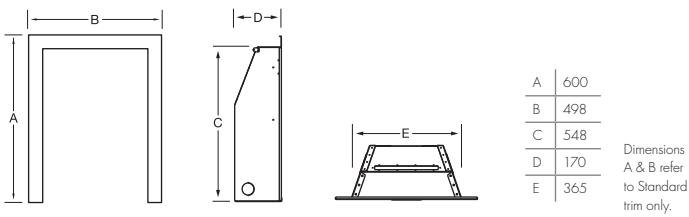

DELAMERE PLUS

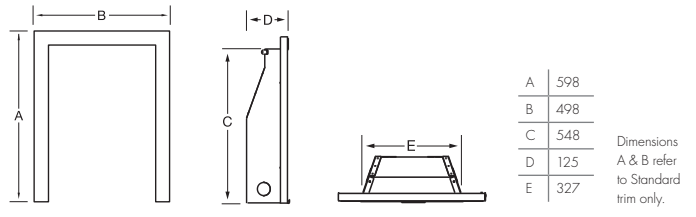

MARBURY PLUS

Hearth Inset - Glass Fronted – 23

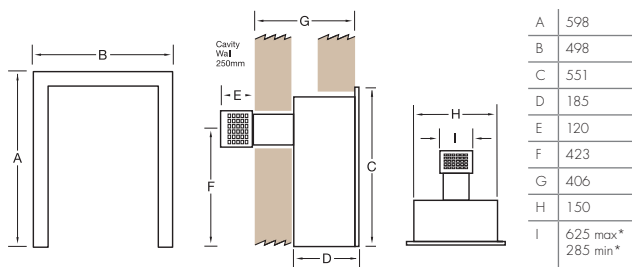

Dimensions A & B refer to Standard trim only. *These dimensions differ on EFC models. Please refer to the installation manual for more details. An optional flue extension is available for Natural Gas Only products to increase the maximum flue length to 1010mm on manual control models and 973mm on EFC models.

DURLSTON

Hearth Inset - Open Fronted - 24-27

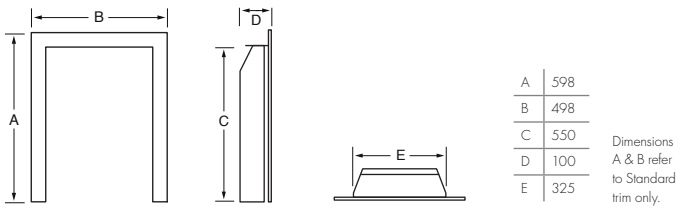

MARBURY

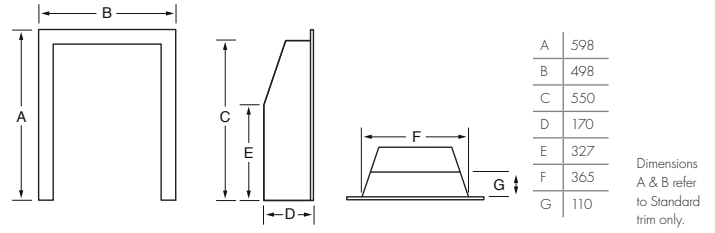

DELAMERE

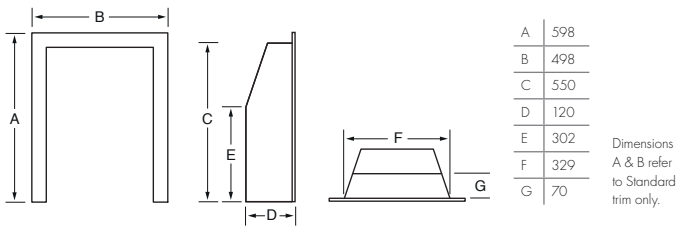

THETFORD

FLAVEL

Hearth Inset - Glass Fronted - 30-31

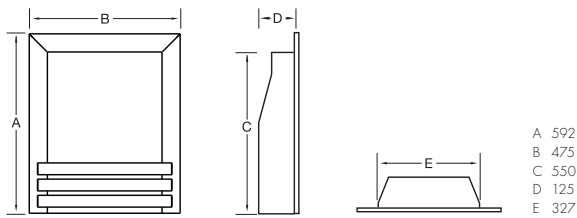

WINDSOR CONTEMPORARY HE

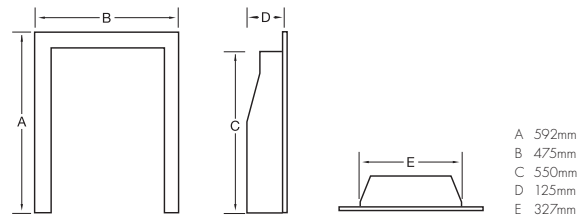

WINDSOR TRADITIONAL HE

Hearth Outset - Glass Fronted - 32-33

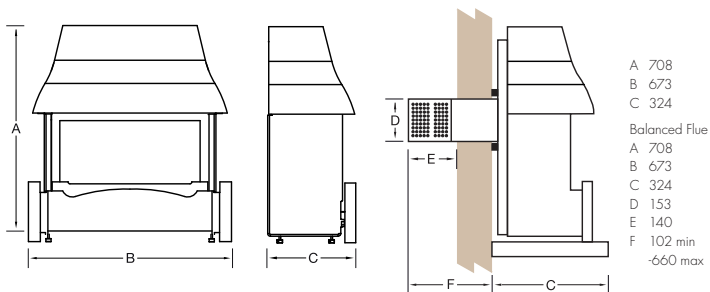

EMBERGLOW

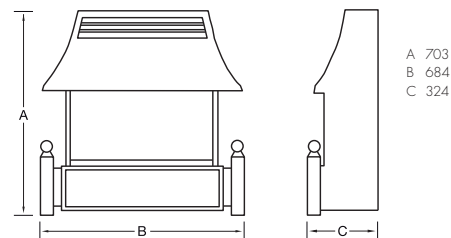

RENOIR

DIMENSIONS



Hearth Outset - Open Fronted – 34-39

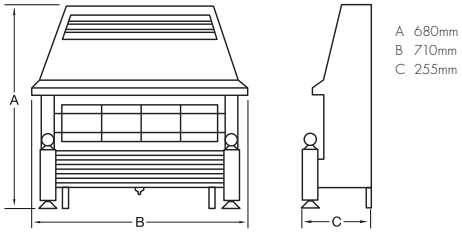

REGENT

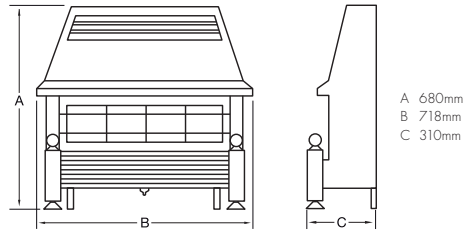

WELCOME

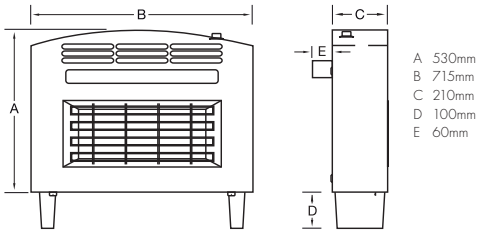

STRATA

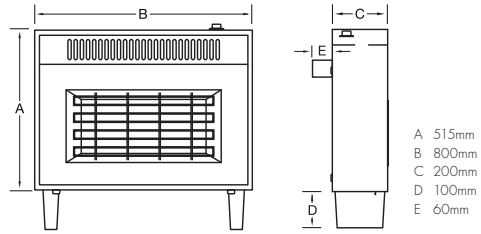

MISERMATIC

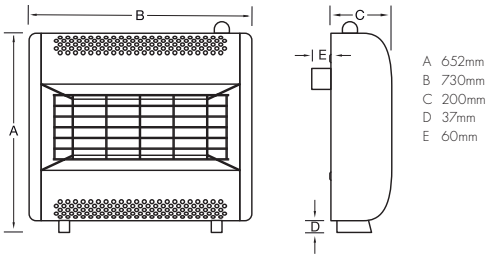

RENAISSANCE

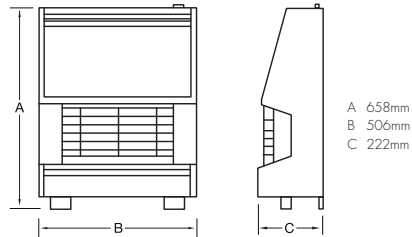

FIRENZA

Hearth Inset - Open Fronted – 40

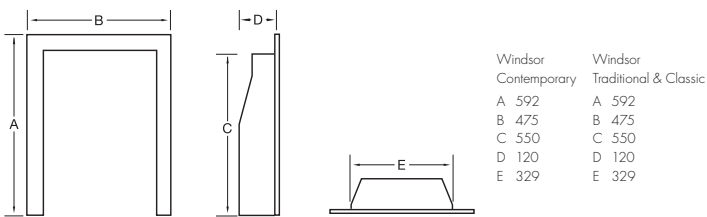

WINDSOR CONTEMPORARY, CLASSIC & TRADITIONAL

Hearth Outset - Open Fronted – 41

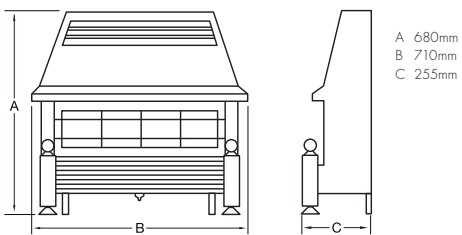

REGENT LFE

ELECTRIFLAME® VR

Outset Suites - Glass Fronted – 42-49

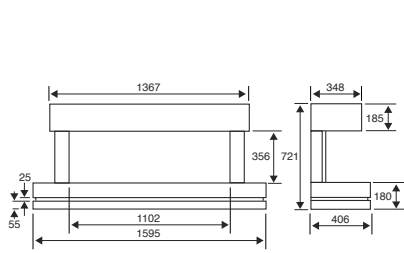

VOLARE 1100 ILLUMIA

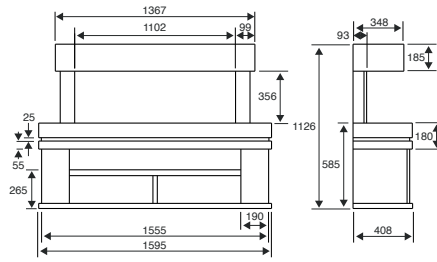

MEDIA 1100 ILLUMIA

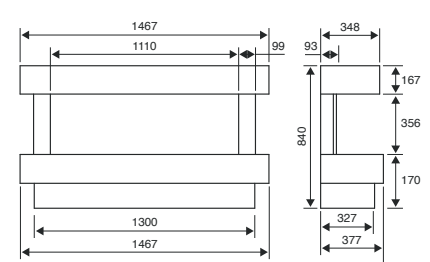

CARINO 1100 ILLUMIA

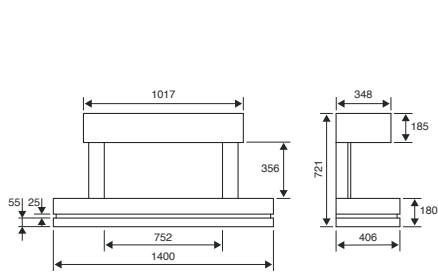

VOLARE 750 ILLUMIA

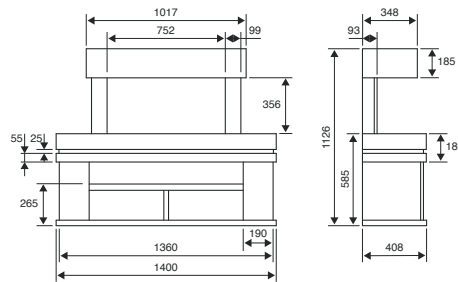

MEDIA 750 ILLUMIA

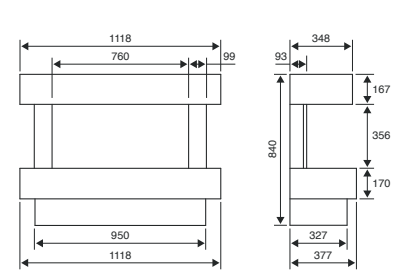

CARINO 750 ILLUMIA

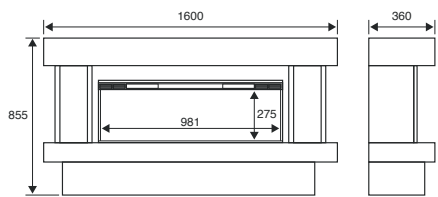

ORBITAL ILLUMIA

Wall Outset - Glass Fronted – 50-54

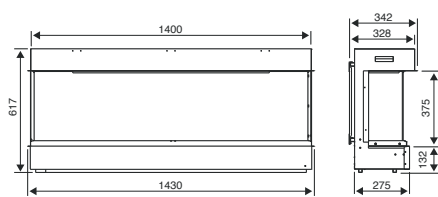

1400

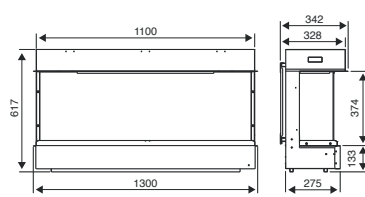

1100

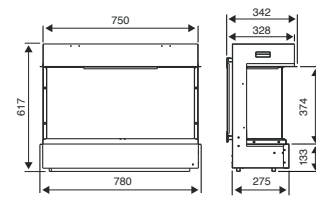

750

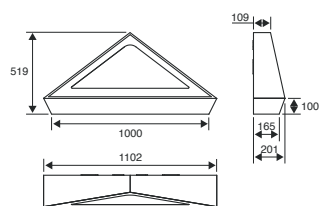

LOUVRE

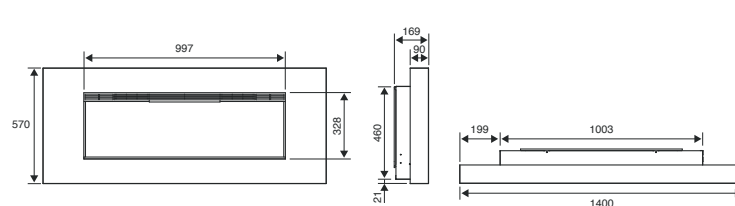

BASILICA

ELECTRIFLAME® VR

Wall Inset - Glass Fronted – 55-57

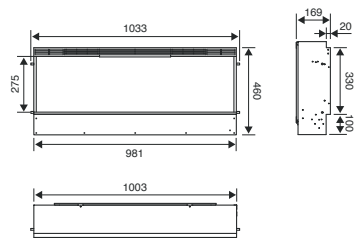

COMMODUS

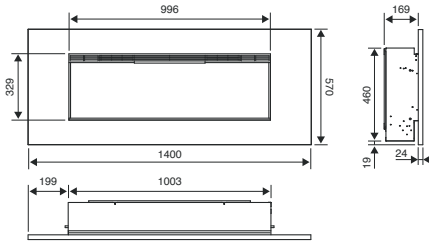

METZ

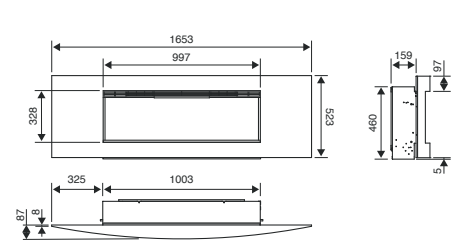

VICHY

Hearth Inset – 58-60

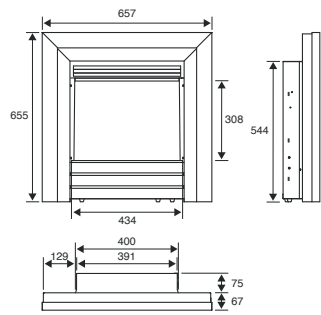

ACERO

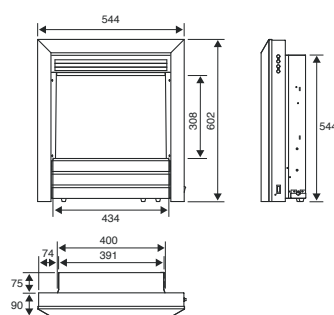

PARRILLA

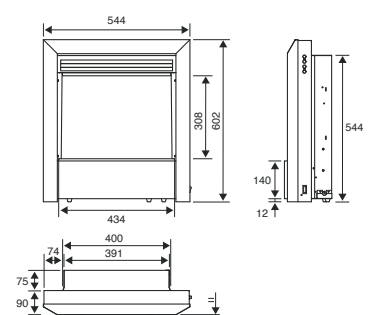

CONTEMPORARY

ELECTRISTOVE® VR

Outlet Stoves - Glass Fronted – 61-63

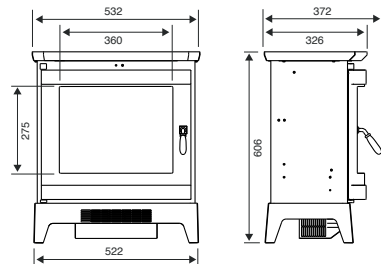

ROCHESTER

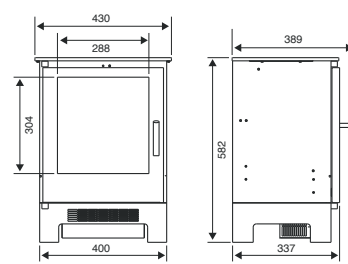

ARUNDEL

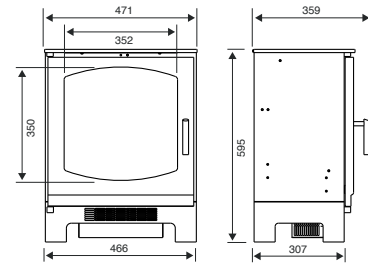

LUXIMA

ULTIFLAME® VR

Outlet Suites - Open Fronted - 64-67

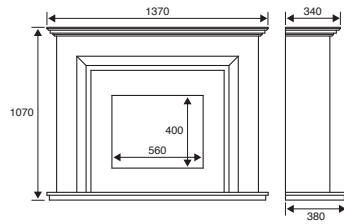
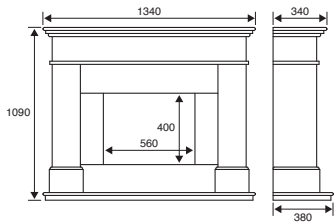

TORY ILLUMIA

RATHLIN ILLUMIA

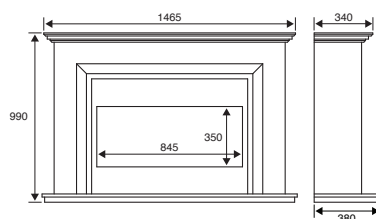
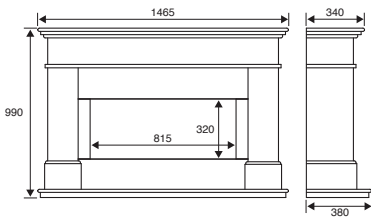

GOLA ILLUMIA

ARAN 750 ILLUMIA

Hearth Inset - Open Fronted - 68-70

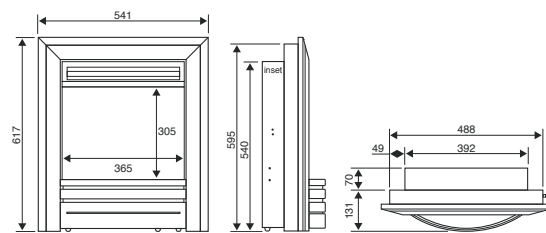
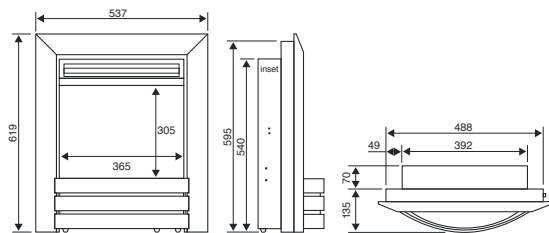

CAMBER

FRONTIER

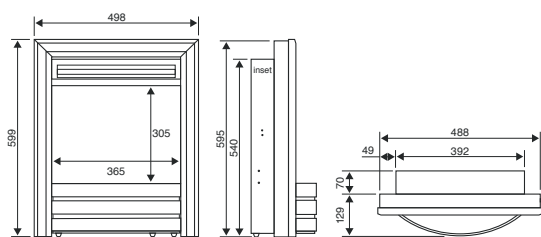

DESIGNER

FLAMONIK

Wall Outset - Glass Fronted – 71-72

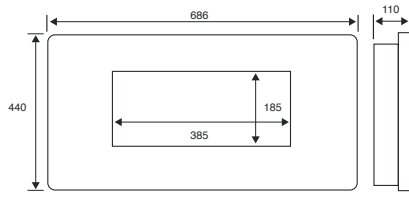

RAPTURE

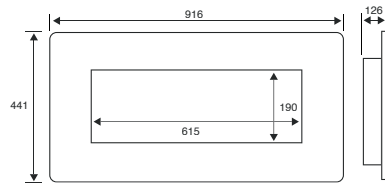

ENCHANT

ACCENT

Hearth Inset - Open Fronted – 73-74

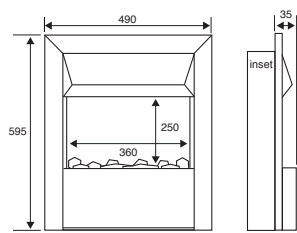

ACCENT TRADITIONAL

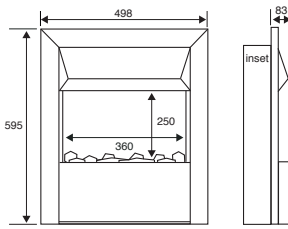

ACCENT INFUSION

ELECTRISTOVE® XD & PURASTOVE

Outlet Stoves - Glass Fronted – 75-77

METAL 1

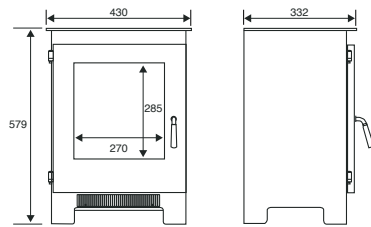

ELECTRISTOVE METAL

METAL 2

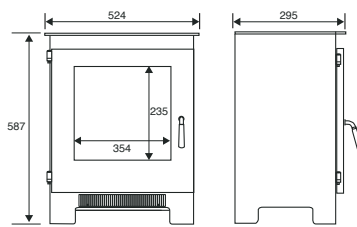

GLASS 1

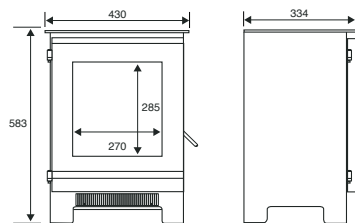

ELECTRISTOVE GLASS

GLASS 2

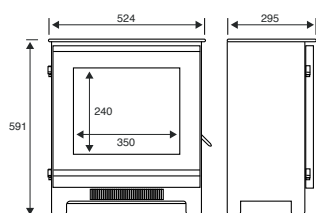
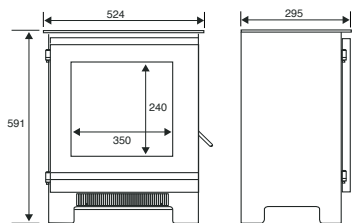

GLASS 2

Vertical balanced flue installation

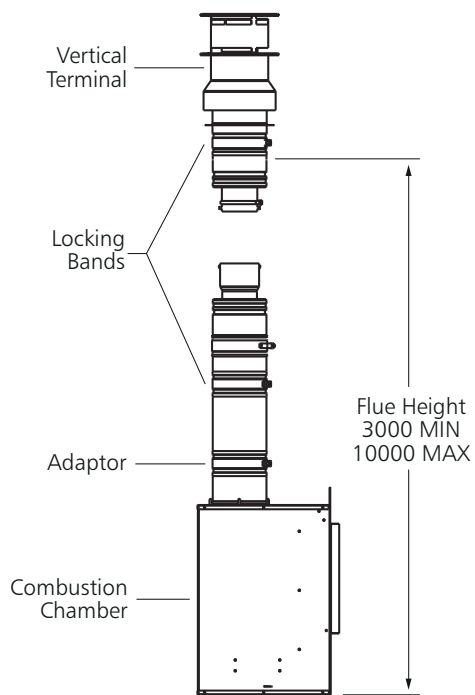

Horizontal balanced flue installation

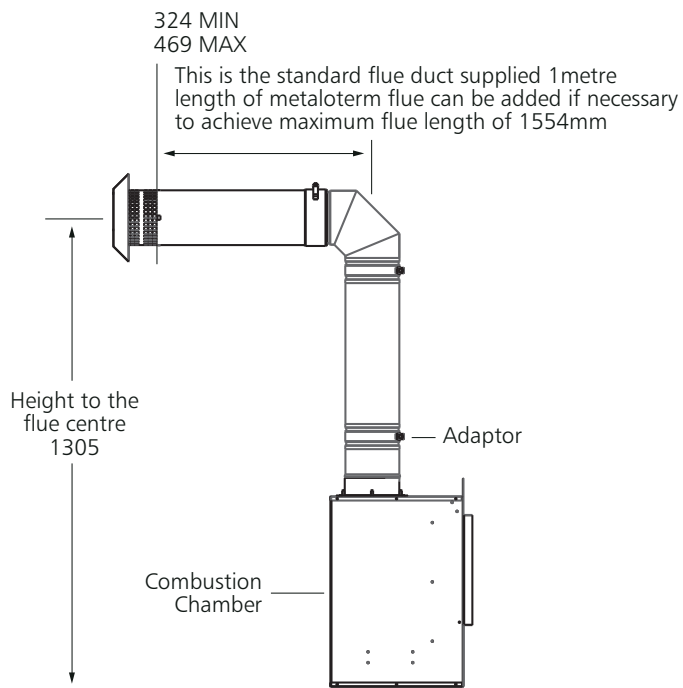

Chimney conversion balanced flue kit

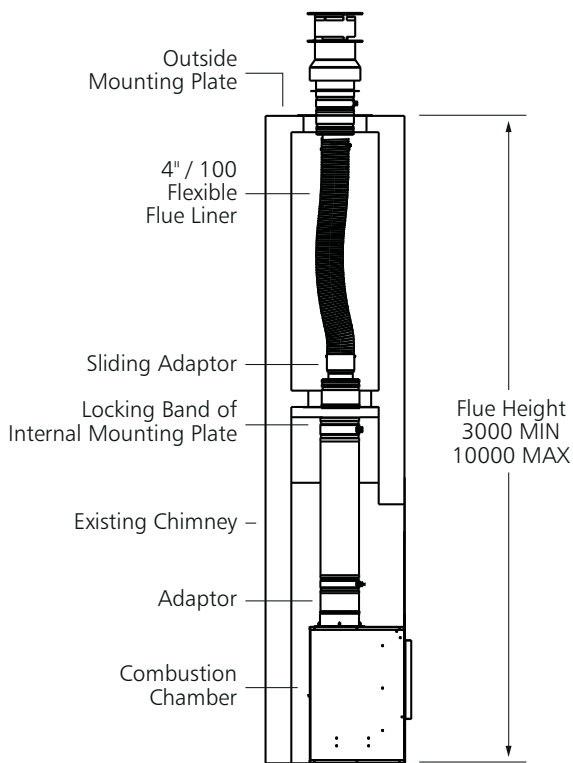



BFM Europe

BRITISH FIRE MANUFACTURERS

BFM Europe Ltd, Gordon Banks Drive,
Trentham Lakes, Stoke-on-Trent ST4 4TJ
Tel: 01782 339000
Email: sales@bfm-europe.com

www.bfm-europe.com

Go direct to the BFM website on your smart phone or tablet device and use the app to scan the black and white QR codes shown on each page. Alternatively, go to www.bfm-europe.com to browse all the fires.



DISCLAIMER

Our policy is one of constant development and improvement. We therefore reserve the right to revise designs and specifications of our products without formal notice, patents pending. We always recommend our products be viewed in an approved showroom before purchase. Whilst we have taken every care in the preparation of this brochure it is not intended to replace the installation manual which provides more detailed information.

Photography is for illustration purposes only and although every effort has been made to ensure accurate reproduction of typical installations and flame pictures they may vary according to fire model and flue types.

We accept no liability for any loss or damage arising directly or indirectly from the use of this brochure.

We recommend that all our fires are used in conjunction with central heating and not as a primary source of heat.

In the interests of personal safety a suitable fireguard is recommended when children, the elderly and the infirm are present. (This brochure is copyright 2019 and must not be reproduced in whole or in any part without prior written permission).